



GERMAN ASSOCIATION OF CONSULTING ENGINEERS

VERBAND BERATENDER  
INGENIEURE

# RENEWABLE ENERGY

Lessons from the German Experience of the Energy Transition  
A Guide for Engineers, Policymakers and Administrators

VBI Guide

# Imprint

## **Publisher**

German Association of Consulting Engineers  
Budapester Str. 31  
10787 Berlin  
Tel: +49 (0) 30 26062 0  
Fax: : +49 (0) 30 26062 100  
Email: [vbi@vbi.de](mailto:vbi@vbi.de)  
Website: <https://www.vbi.de/english/>

If you are looking for a partner to help you plan your project:



## **Legal responsibility**

VBI, Berlin, Germany

## **Editors**

RENAC, Berlin, Germany

Copyright © 2019 Verband Beratender Ingenieure (VBI)

All rights reserved.

First Edition, April 2019

## **Important note**

While the publishers, editors and authors of this work believe that the information and guidance given in this work are correct, all parties must rely upon their own skill and judgement when making use of them – it is not meant to be a replacement for manufacturer’s instructions, legal technical codes or professional advice. Neither the author(s) nor the publisher assumes any liability for any loss or damage caused by any error or omission in the work. Any and all such liability is disclaimed.

Die Inhalte dieser Broschüre sind nicht als Rechtsberatung aufzufassen. Das Lesen dieser Broschüre kann eine umfassende Rechtsberatung nicht ersetzen.



VERBAND BERATENDER  
INGENIEURE

# **VBI Guide to Renewable Energy**

## Content

<b>1</b>	<b>Introduction .....</b>	<b>8</b>
<b>2</b>	<b>Market Situation and Current Figures for Renewable Energy .....</b>	<b>10</b>
2.1	The energy transition in Germany.....	14
2.2	International climate protection policies and emissions trading.....	17
2.3	Incentive mechanisms .....	29
<b>3</b>	<b>Technologies .....</b>	<b>36</b>
3.1	The renewable energy mix .....	36
3.1.1	Solar thermal – heat production .....	39
3.1.2	Solar thermal – electricity generation .....	43
3.1.3	Photovoltaics .....	49
3.1.4	Biomass.....	52
3.1.5	Biogas plants .....	55
3.1.6	Wind energy – onshore and offshore, and its connection to the grid .....	58
3.1.7	Geothermal .....	61
3.1.8	Hydroelectric power .....	72
3.1.9	Hybrid systems .....	77
3.1.9.1	Definitions, characteristics, examples .....	77
3.1.9.2	Hybrid systems – design aspects.....	81
3.1.10	Combined heat and power (CHP) plants .....	85
3.2	Power transmission, distribution and management.....	88
3.2.1	The challenge of renewables – the German power grid .....	88
3.2.1.1	Grid integration of renewable energy .....	90
3.2.1.2	Demand side management .....	94
3.2.1.3	Mini-grids and renewables-based power generation.....	95
3.2.1.4	Smart grids – intelligent networks in tomorrow’s energy systems .....	101
3.2.1.5	High-voltage DC transmission (HVDC).....	104
3.2.2	Gas networks .....	109
3.2.3	Heating and cooling networks .....	111
3.3	Energy storage.....	115
3.3.1	Mechanical storage.....	115
3.3.1.1	Pumped-storage hydroelectric plants.....	115
3.3.1.2	Gravity storage.....	120

3.3.1.3	Compressed air energy storage.....	121
3.3.2	Thermal storage.....	124
3.3.3	Electrochemical energy storage .....	129
3.3.3.1	Batteries for households and electric vehicles .....	129
3.3.3.2	Batteries for system stability .....	130
3.3.4	Chemical energy storage.....	138
3.3.4.1	Hydrogen and electrolysis.....	138
3.3.4.2	Methanation .....	143
3.3.5	Underground gas storage.....	146
<b>4</b>	<b>Project Setup and Implementation .....</b>	<b>150</b>
4.1	Organising the transition towards renewable energy.....	150
4.2	Engineering services .....	152
4.3	Analysis of potential renewable energy resources .....	158
4.4	Energy demand and load analysis.....	162
4.5	Selecting routes for power transmission lines.....	165
4.6	Project management .....	169
4.7	Bankable feasibility study .....	174
4.8	Energy use plan .....	175
4.9	Public acceptance management for international infrastructure projects...	179
<b>5</b>	<b>Economic Viability and Financing .....</b>	<b>185</b>
5.1	Comparative costs of different renewable energy technologies.....	185
5.2	Project financing and related engineering services .....	190
5.3	Funding possibilities for renewable energy projects.....	198
5.4	Independent power producer arrangements.....	200
5.5	Self-consumption and direct marketing of solar power in Germany .....	202
<b>6</b>	<b>Consulting Engineering Services – Remuneration .....</b>	<b>207</b>
<b>7</b>	<b>Abbreviations.....</b>	<b>212</b>

## Authors

Oliver Baudson, TSK Flagsol

Francois Botreau, M. Eng., Lahmeyer International GmbH

Dipl.-Ing. Arch. Bettina Dittmer, atelier4d Architekten

Dr. Stefan Drenkard, Lahmeyer International GmbH

Dipl.-Ing. (TU) Dr. h.c. Adolf Feizlmayr, ILF Beratende Ingenieure GmbH

Dr. rer. nat. Ulrich R. Fischer, Brandenburgische Technische Universität Cottbus

Wi.-Ing. Paul Freunsch, M.Sc., GOPA-International Energy Consultants GmbH

Dipl.-Ing. Reinhard Fritzer, ILF Beratende Ingenieure GmbH

Julia Hage, M.Sc., Fichtner GmbH & Co. KG

Philipp A. Hiersemenzel, B.Sc. (Econ), Aggreko Microgrid & Storage Solutions, Lumenion

Jerrit Hilgedieck, M.Sc., Technische Universität Hamburg (TUHH)

Dipl.-Ing. Ingolf Hoffmann, Lahmeyer International GmbH

Jürgen Hogrefe, hogrefe consult

Prof. Martin Kaltschmitt, Technische Universität Hamburg (TUHH)

Michel Kneller, M.Sc., ILF Beratende Ingenieure GmbH

Dr.-Ing. Andreas Koch, European Institute for Energy Research (EIFER)

Dipl. Wirtsch.-Ing. Jens Kottsieper, ILF Beratende Ingenieure GmbH

Dipl.-Ing. Thomas Kraneis, Verband Beratender Ingenieure (VBI)

Dr. Enrique Kremers, European Institute for Energy Research (EIFER)

Dipl.-Ing. Fabian Kuhn, Fichtner GmbH & Co. KG

Alex Loosen, M.Sc. (Renewable Energy), Lahmeyer International GmbH

Annika Magdowski, M.Sc., Technische Universität Hamburg (TUHH)

Dr. Atom Mirakyan, Lahmeyer International GmbH

Dipl.-Ing. Hans Neumeister, ILF Beratende Ingenieure GmbH

Dipl.-Ing. Henry Och, Dr. Born – Dr. Ermel GmbH – Ingenieure

Dipl.-Ing. Heiko Peters, Dr. Born – Dr. Ermel GmbH – Ingenieure

Dipl.-Ing. Christopher Vagn Philipsen, Drees & Sommer

Prof. Dr. rer. nat. Dipl.-Geol. Ingo Sass, Technische Universität Darmstadt

Dipl.-Geol. Steffen Schmitz, DBI Gas- und Umwelttechnik GmbH

Dr.-Ing. Dirk Schramm, Ingenieurbüro für Energiewirtschaft

Dipl.-Ing. Heiner Schröder, Dr. Born – Dr. Ermel GmbH – Ingenieure  
Thomas Schubert, LL.M. (Boston), Dentons Europe LLP  
Prof. Dr.-Ing. Harald Schwarz, Brandenburgische Technische Universität Cottbus  
Manuel Seidenkranz, M.Sc., ILF Beratende Ingenieure GmbH  
Dipl.-Psych. Christian Semmler, Alternative Energien Wachsen  
Dipl.-Ing. Arno Stomberg, Dr. Born – Dr. Ermel GmbH – Ingenieure  
Univ. Prof. Dipl. Ing. Dr. techn. Wolfgang Streicher, Universität Innsbruck  
Ing. Walter Walkobinger, M.Sc. (GIS), ILF Beratende Ingenieure GmbH  
Mag. Manfred Watzal, ILF Beratende Ingenieure GmbH  
Prof. Dr.-Ing. Andreas Wiese, GOPA-International Energy Consultants GmbH  
Dr. Sc. ETH Mech. Eng. Giw Zanganeh, ALACAES SA





## Foreword

Global warming is to be limited to below 2°C by 2050. This goal was set at the Paris Climate Change Conference and is only possible through the consistent implementation of smart and sustainable energy solutions. Renewable energy technologies and energy efficiency reduce dependence on fossil fuels, contribute to climate protection, help to reduce energy costs and strengthen competitiveness. From our experience with the German energy transition – the transition from fossil and nuclear fuels towards renewable energy and better energy efficiency – we know that linking different sources of renewable energy, electricity and heating networks, energy storage systems and innovative technologies to intelligent energy systems is becoming increasingly important. Digitalisation plays a key role in ensuring a secure energy supply that includes high proportions of energy from intermittent renewable sources.



This *VBI Guide to Renewable Energy* explains the range of technologies that are suitable and indispensable for an energy transition. An understanding of these technologies is important for the planning of a future-oriented, modern, smart and sustainable energy supply based on renewable energy and energy efficiency, the two most important pillars of this transition. This guide leads the reader through the individual phases of planning and implementation of often complex projects, and provides valuable information on financing issues, but also on the transparent communication necessary for the successful implementation of infrastructure projects. This VBI guide is aimed at decision makers and project participants, such as local policymakers, engineers, architects, investors and other service providers, in particular internationally, in order to share insights from the German energy transition and resulting expertise.

The German Energy Solutions Initiative has gladly supported VBI in the publication of this guide. Via this initiative, the German Federal Ministry for Economic Affairs and Energy wishes to make a contribution to the Paris Accord climate protection goal by disseminating information on German smart and sustainable energy technologies and services. The key to success will especially be the creativity, expertise and innovation abilities of engineers.

I wish you an interesting and helpful read.

Christina Wittek

Head of Division I German Energy Solutions Initiative

German Federal Ministry for Economic Affairs and Energy

# 1 Introduction

*Adolf Feizlmayr, Thomas Kraneis*

At the world climate change conference (COP21) in Paris at the beginning of December 2015, the international community committed itself to limiting the average global warming related temperature rise to well below 2°C compared to pre-industrial levels. In addition to this commitment, all parties agreed to ‘pursue efforts’ to limit this temperature rise to 1.5°C. The long history of the Club of Rome’s *The Limits to Growth* study, published in 1972, through to 2015, is described in Chapter 2.2. Achieving the goal agreed in Paris in 2015, and finally confirmed at COP24 in Katowice, Poland in December 2018, requires a global energy transition which includes the following measures:

- Reducing energy consumption
- Increasing energy efficiency
- Reducing and/or avoiding the use of fossil energy sources via the increased use of renewable energy sources such as hydropower, wind power, solar power, geothermal power, energy from biomass and tidal power
- Capturing CO<sub>2</sub> from the flue gases of fossil fuel power plants – and storing it underground (carbon capture and storage) or utilising it (carbon capture and utilisation).

The implementation of these measures in the context of an energy transition from fossil fuels towards renewable energy sources requires the creativity and expertise of policymakers and engineers. This guide offers the opportunity for others to learn from the positive and negative experiences of the German energy transition by methodically discussing its technical characteristics. Those lessons can be transferred to the specific requirements of other countries. A systematic approach to energy transition is recommended. The engineering services which are available for the introduction and expansion of renewable energy technologies are described in Chapter 4. The greatest challenge faced – as described in that chapter – when implementing the energy transition is how to select a balanced energy mix which can achieve the internationally-agreed climate target. It is not simply about defining the goal, it is also about how to attain it. A prerequisite for the development of the appropriate energy mix is the possession of a sound knowledge of all the possible technologies that might be suitable for an overall energy concept. The current state of the art of the various renewable energy technologies is described in Chapter 3. However, because dynamic developments are taking place in many technology areas, it is also necessary to continuously adapt energy concepts in order to take advantage of the latest technical advances and research results. Although the long-term goal of the energy transition is to replace fossil fuels completely with renewables, the continuing (but decreasing) use of fossil-fuel will continue

as a part of the road to decarbonisation and to a balanced energy mix. Decarbonisation goes along with increasing electrification of the energy supply in some countries. With an increasing proportion of renewable energy in the energy mix, controlling and regulating natural short-term fluctuations/variations in the supply of 'intermittent' wind and solar energy will pose a major challenge. This can be achieved through the digitalisation of energy supply systems, the upgrading and expansion of electric power grids and other energy supply networks, with corresponding short-term and long-term energy storage facilities – and here considerable research and entrepreneurial pioneering spirit is needed.

Three factors are crucial when designing a balanced energy mix concept and the corresponding overall energy concept: lowering CO<sub>2</sub> emissions, ensuring security of supply, and assuring energy affordability. Chapter 5 deals with the economic aspects of implementing the energy transition. Happily, from the point of view of climate protection, many renewable energy technologies are now cost-competitive with newly built fossil-fuel and nuclear power plants. When renewable energy technologies were first introduced onto the market and in the early phases of their expansion, considerable state support measures were required in some cases. Possible financial incentive mechanisms and funding opportunities for the renewable energy sector are described in Chapter 2.3.

There will be considerable differences between the energy supply concepts in different regions and countries. In the industrialised countries, this means a large-scale restructuring of existing energy supply systems; the aim will be to find solutions by which the CO<sub>2</sub>-avoidance costs are kept as low as possible in order that energy remains affordable and there is reliable supply security. In the less industrially-developed countries, efforts should be made to build up the energy supply from the outset in line with the Paris Agreement. Worldwide, nearly a billion people still have no access to electricity. The vast majority of these people live in sub-Saharan Africa and in parts of Asia. Energy supply is of crucial importance for further economic development in these regions. A major advantage of renewable energy technologies is that they are particularly well suited for decentralised energy solutions. However, there are no panaceas or single solutions. Each country requires a tailor-made energy concept which, while taking local conditions into account, can achieve the climate protection objectives of the Paris Agreement in the best possible way.

The VBI – the German Association of Consulting Engineers or the Verband Beratender Ingenieure – has about 3,000 company members who employ more than 45,000 highly skilled consultants and engineers. The VBI's consulting engineers are specialists in designing the energy systems that the transition towards renewable energy requires, and in collaborating on their implementation.

## 2 Market Situation and Current Figures for Renewable Energy

*Thomas Kraneis*

The economic strength of the renewable energy industry is reflected in, among other things, the creation of employment internationally as well as green electricity production. Even though production of equipment is largely highly automated, by the middle of 2018 there will be 10.5 million people employed in the industry around the world. The industry's annual growth rate averaged 5.4% in 2017, with just under 10% of this being solar. More than 70% of the new jobs were created in China, Brazil, USA, India, Germany and Japan. In Germany, more than 228 billion kWh of green electricity was generated in 2018, with renewables comprising just over 35% of electricity production.

By mid-2018, photovoltaic (PV) plants with a capacity of more than 400 GW were installed worldwide, which roughly corresponds to the rated power output capacity (nameplate capacity) of 94 nuclear power plants. However, PV power plants, depending on where the system is located, can generate only a maximum of one eighth of the energy produced by the nuclear power plants of the same rated power output capacity.

The use of bioenergy and geothermal heat is increasing by up to 10% per year. The use of bioenergy, especially, will create hundreds of thousands of jobs in rural areas. Optimised drilling techniques are also making geothermal energy more and more economically viable. The drilling costs for geothermal energy are now less than 3 US cents per kWh [1].

The global installed capacity of the different renewable energy technologies in 2017 is given in Table 2.1. At the end of 2017, 2,345 GW capacity of electricity generation from renewable energy had been installed globally.

More is currently being invested in renewable energy around the world than in traditional fossil fuel power plants. The ratio is about 65 to 35% in favour of renewables. This also includes hydropower plant projects. In the hydropower sector, Africa still has a considerable potential: less than 10% of the continent's potential hydropower is being harnessed.

More and more national and international financial institutions are refusing to finance fossil fuel power plants. This has led to a dramatic decline in orders for fossil fuel power plants. The poor orderbook situation has already led to layoffs of workers worldwide. These strategic financial decisions by banks to stop financing fossil fuel power plants

Technology	Installed capacity
Hydropower	1,267 GW
Marine renewable energy	547 MW
Wind energy	539 GW
Solar energy	
Solar thermal (heat only)	472 GW
Solar thermal electric power	5.1 GW
Photovoltaics – electric power	397 GW
Geothermal	
Heat production	79 GW
Near-surface geothermal	56 GW
Deep geothermal	23 GW
Geothermal – electric power	14 GW
Biomass	314 GW
Biogas	25 GW
Biomass – electric power production	112 GW
Fuel production	
Bioethanol	105.5 billion litres
Biodiesel	36.6 billion litres

Table 2.1: Global installed capacity of different renewable energy technologies in 2017. | Source: BHKW, Erneuerbare Energien Special 7/8 – 2018.

favour the development of renewable energy technologies; while, on the other hand, current low interest rates facilitate the easier raising of finance for renewable energy projects in many parts of the world. These trends support the goal of limiting the negative effects of climate change.

With the Paris Agreement on climate protection from the Paris Climate Change Conference (COP21), which came into force in 2016, the goal of limiting the global rise in temperature to a maximum of 2°C through the increased use of renewable energy becomes achievable. Many national and international efforts and agreements mark the way. However, the intended global exit from coal use is sluggish and this remains a major challenge. As a result, global CO<sub>2</sub> emissions will be reduced only slowly. The polar ice sheets and glacial ice masses are melting slowly but inexorably. Sea levels will increase in the future and flood large areas. The people living in these areas will have to be resettled. This will affect about 80 million people in Bangladesh alone in the next 30 – 50 years.

Due to the increasing mass production of both manufacturing technology and of end products in the renewable energy industry, investment costs for manufacturers and the technology users have fallen sharply. In the solar energy industry, for example, the production costs of PV systems and concentrating solar power (CSP) technology have fallen by almost 90% in the last 15 years. Mass production of PV modules in Asia has brought about world market prices that seemed unthinkable 10 years ago. Further cost reductions can be expected in the future. The situation with regard to the wind energy industry is similar. In particular, the use of large-sized machines of up to 10 MW in the offshore sector has resulted in considerable cost reductions.

Similar trends can also be seen in other areas of the renewable energy industry. This will particularly benefit the rural electrification sector, where the share of renewable energy in electricity generation in rural areas will further increase. Also, for example, power purchase agreements (PPAs) for power generated from renewable energy are now wholly competitive with conventional power generation technologies. PPAs now make possible electricity prices for consumers of between 3.5 to 5 US cents per kWh. This trend is particularly pronounced in the USA, in the UAE and in Saudi Arabia [3] [4].

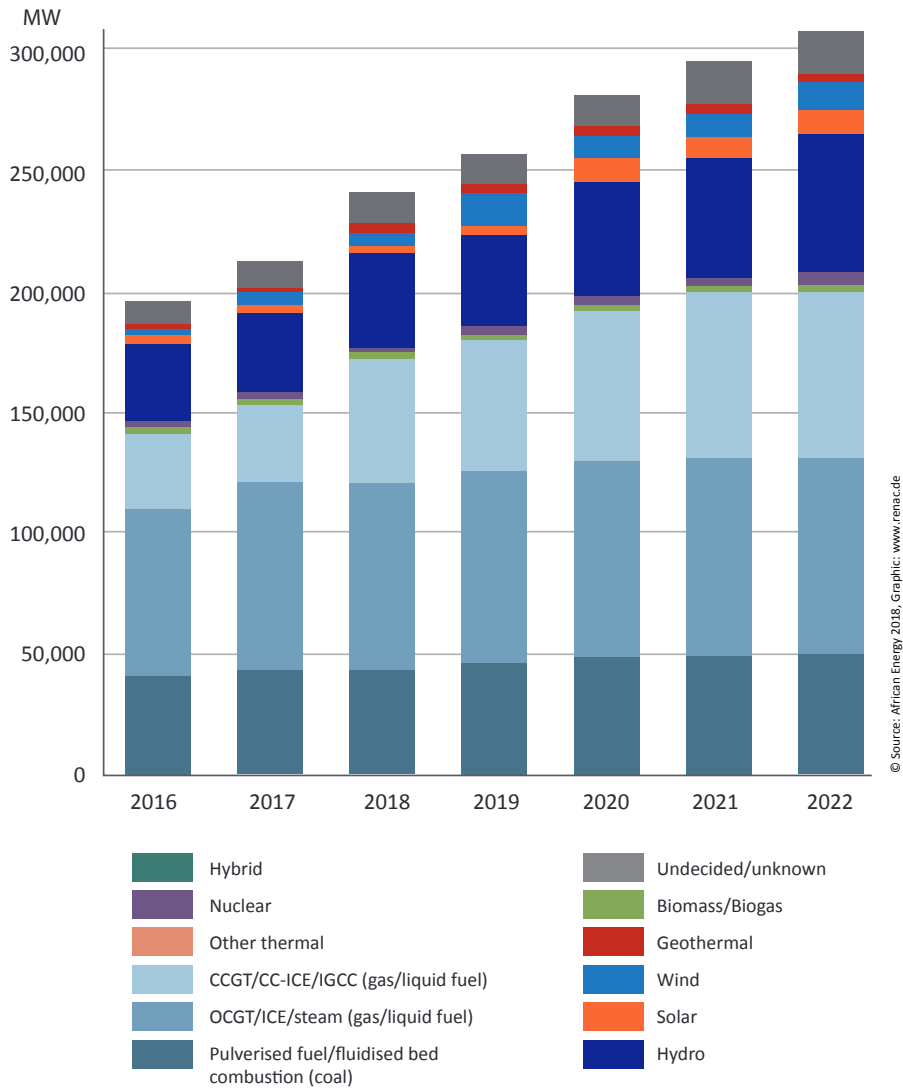


Figure 2.1: Installed capacity by technology type in Africa 2016 – 2022. | Source: African Energy 2018.

## 2.1 The energy transition in Germany

Thomas Kraneis

The implementation of the German energy transition programme from fossil fuels to renewable energy will be successful if energy efficiency can be increased, the installation of renewable energy systems continues to forge ahead, a reduction in energy demand can be implemented, and the issue of energy storage can be resolved. This chapter focuses on the expansion of renewable energy in Germany, particularly with regards to electricity generation. The energy transition as regards electric power generation in Germany is a success story. In 2018, renewable energy reached over 35% of the market share for electricity generation in Germany for the first time. This is due to the construction of additional facilities in recent years, but also to the favourable weather in 2018 – both average wind speeds and solar irradiation levels were particularly high. In general, power generation from wind turbines, onshore and offshore, accounts for the largest share of gross electricity generation – at 16.3% – from renewable sources of energy. The contribution from photovoltaics and biomass, at more than 13% together, is also particularly high.

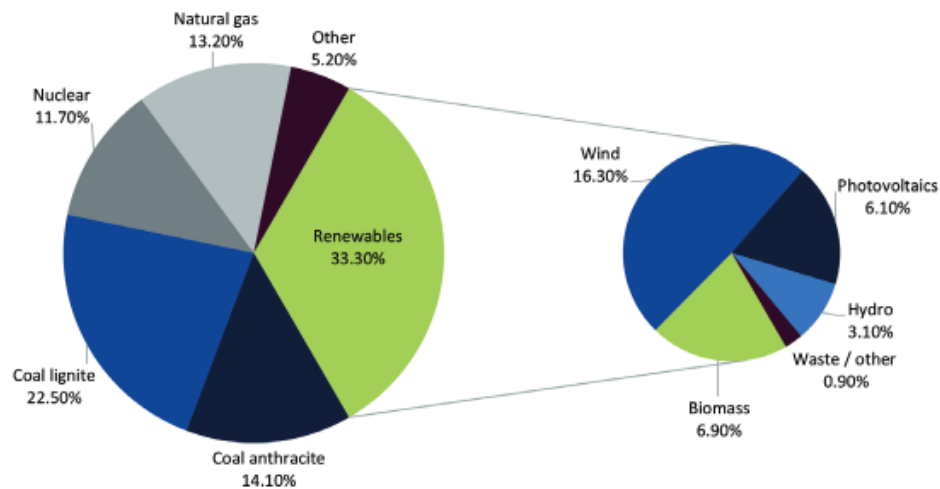


Figure 2.1.1: Gross electricity production Germany in 2018. | Source: World Energy Council Germany (Weltenergieerat Deutschland), 2018. | Graphic: RENAC.

Planned investment in the construction of renewable energy plants and systems in Germany in 2018 was almost €27 billion, of which a good €9.3 billion was for electricity generation, a reduction of 32% on 2017. There were more than 350,000 jobs in the industry by mid-2018. However, fossil fuels and nuclear power, at approximately 67%, still account for the lion's share of electricity generation in Germany. The BDEW (the



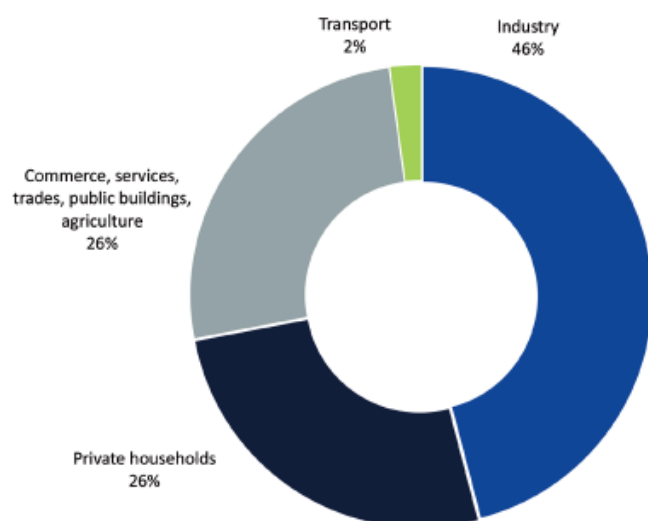


Figure 2.1.2: German net electricity consumption according to sector, 2017. | Source: World Energy Council Germany (Weltenergieerat Deutschland), 2018. | Graphic: RENAC.

German Federal Association of Energy and Water Management) has calculated the full load hours for power plants in Germany for 2017 (see Table 2.1.1).

Technology	Full load hours, 2017
Nuclear power	6,880
Coal – lignite	6,490
Biomass	5,720
Run-of-the-river and hydroelectric storage power plants	3,570
Coal – anthracite	3,570
Wind power offshore	3,690
Natural gas	2,820
Wind power onshore	1,820
Petroleum	1,130
Pumped-storage hydroelectric	1,020
Photovoltaics	940

Table 2.1.1: Full load hours of electricity generating plants in Germany, 2017. | Source: World Energy Council Germany (Weltenergieerat Deutschland), 2018.

In total, 70% of German energy consumption was supplied from imported energy sources in 2017 with the Russian Federation as the most important supplier. The supply of renewable electricity in that year helped to reduce this and was offsetting more than €10 billion in fossil fuel imports.

All German nuclear power plants will be taken offline by 2022. The resulting shortfall, with regards to installed capacity and power generation, will have to be made up either by the use of fossil primary energy sources, such as coal or natural gas, or by renewable energy sources, efficiency gains and energy savings (reductions in energy demand). Currently, it looks as if the planned increase in wind power capacity, as well as in photovoltaics and other renewable energy technologies, will be able to cover this shortfall by 2022.

According to the BDEW, VGB, the Bundesnetzagentur (BNetzA) and the Renewable Energy Statistics Working Group (Arbeitsgruppe Erneuerbare Energien-Statistik or AGEE), there was a total of 215,846 MW of installed capacity of electric power generation in Germany at the end of February 2018, and more than 50% of that came from renewable energy technologies.

In total, there are 1.6 million households in Germany that generate electricity, mostly from rooftop photovoltaic systems. The status of these electricity producers (also called 'prosumers', because they both produce and consume) on the electricity market is largely equivalent, with regard to grid network access and selling electricity, to that of the larger energy supply companies. 'Self-consumption' of the electricity generated by these households is promoted/preferred, but surplus electricity is fed into the grid and is remunerated by the network operators according to whatever contracts are in place.

The reasons for the growing interest in self-consumption of photovoltaic-generated electricity in Germany are: energy taxes, the tariff structure specified in the German Renewable Energy Sources Act or EEG (German: *Erneuerbare-Energien-Gesetz*), and relatively high electricity prices in Germany (in comparison to other industrialised countries). Self-consumption therefore makes more economic sense for private individuals than purchasing electricity from the grid.

Due to the renewable energy auction schemes initiated by the German government in 2016, public financial support (subsidies) for wind power and photovoltaic systems will henceforth decline significantly.

Offshore wind turbines with individual output capacities of up to 10 MW are no longer dependent on subsidies to be economically viable. Investors for offshore wind farms in German territorial waters can be found worldwide. These modern sea-based wind turbines have heights of more than 145 metres. The average hub height of the latest machines is over 100 metres.

The Climate Action Plan 2050, which was passed by the German cabinet in 2016 in time for the UN Climate Change Conference in Marrakech, Morocco, forms the basis for the implementation of Germany's long-term climate protection strategy. The plan provides orientation for all actors in business, science and society. However, it is not yet clear whether the planned transformation of the economy and of society, which is required to reach near-complete greenhouse gas neutrality, can actually be achieved by 2050.

For an industrial country, Germany has very high electricity costs. This has increasingly led to power-intensive manufacturing facilities moving abroad. The German government is trying to counteract this trend by means of special agreements with industry. Along with Denmark, Germany has the highest household tariffs for electricity.

To date, the problem of energy storage has only been resolved on a rudimentary level. Further technologies need to be researched and developed in order that energy from renewable sources can contribute to sector coupling (German: *Sektorkopplung*) – the interconnection of the different sectors of energy-related industries (electricity, heat and transport). 'Sector coupling refers to the interconnecting of the different sectors of the energy industry, as well as industry in general, in a holistic approach which optimises the whole energy supply system [2]. A reduction in the number of reserve power plants can only be expected if the energy storage problem is solved [3].

## **2.2 International climate protection policies and emissions trading**

*Thomas Schubert*

### **From Rio to Kyoto to Paris**

The beginnings of global climate policies go back to the second half of the last century. One of the elements was *The Limits to Growth*, the 1972 study on behalf of the Club of Rome compiled by Donella and Dennis Meadows, which shook and sensitised the world's population, in particular societies in the major industrialised countries, into a rethinking of environmental protection and sustainability issues. Although the

original study did not at the time take the climate change impact of greenhouse gases fully into account, it did address the consequences of the exploitation of natural resources and habitat destruction. One of its conclusions was that absolute 'limits to growth' would be reached by the end of the 21st century if the increase in world population, industrialisation, pollution, food production and exploitation of raw materials continued unabated. And that the sooner the world's population decided to rethink and establish an ecological and economic state of equilibrium, the more likely this state of equilibrium could be achieved. To do so would require international cooperation to implement global action. Two decades later, in June 1992, the groundbreaking international environmental conference, the United Nations Conference on Environment and Development (UNCED), took place in Rio de Janeiro, Brazil. Representatives from 178 countries created a framework for a global development and environmental policy. Among other things, the delegates also adopted the United Nations Framework Convention on Climate Change (UNFCCC), which forms the basis of international law for international climate protection negotiations. This convention has since been ratified by 190 states. The highest decision-making body of the Framework Convention on Climate Change is the Conference of the Parties (COP), which has met annually since 1995. In 1997, the 3rd Conference of the Parties (COP3) took place in Kyoto, Japan. The result of this conference was the so-called Kyoto Protocol. Its ultimate objective was to stabilise the concentration of greenhouse gases in the atmosphere 'at a level that would prevent dangerous anthropogenic (human) interference with the climate system'. Also, the participating industrialised countries committed to set up a fund to finance climate change adaptation and mitigation projects. Flexible mechanisms for achieving greenhouse gas reduction targets were also agreed. The Kyoto Protocol came into force in 2005. It was extended until 2020 at the 18th Conference of the Parties (COP18), in Doha, Qatar.

The mechanisms in the Kyoto Protocol included the Clean Development Mechanism (CDM) and Joint Implementation (JI). The approach here was that it was not absolutely necessary to avoid emissions where they actually occur (in their respective countries); rather, emissions could be avoided where it costs the least – which makes more sense economically. States could therefore be 'credited' for the avoidance of greenhouse gas emissions in other countries, provided the former (the states being 'credited') paid for the investments required. The Kyoto Protocol also formed the basis for international emissions trading, which enabled industrialised countries to trade emission rights among themselves.

However, in order to continue to promote global climate protection for the post-2020 period, new agreements were required that could be supported by the majority of states. Therefore the draft text for a conference in Paris in 2015 was prepared at the 20th Conference of the Parties (COP20) in Lima, Peru. The objectives were to reduce emissions, implement climate change adaptation and mitigation measures, provide financing, promote technology development and transfer, and increase transparency with regard to reviews of the implementation of agreed measures. The participating parties were called upon to submit Intended Nationally Determined Contributions (INDCs) (statements of voluntary national climate targets, including climate change adaptation and mitigation measures, which countries committed to) in time for the Paris Conference.

## Paris – COP21

The turning point for a sustainable global climate policy came with the 21st Conference of the Parties (COP21), at the world climate change conference in Paris, France, at the beginning of December 2015.

Former US President Barak Obama described the agreement reached in Paris as a ‘turning point for the world’, since a climate protection agreement was passed in which it was bindingly agreed to limit the average global temperature rise to ‘well below 2°C above pre-industrial levels’. In addition, it was agreed that joint efforts should be pursued to limit the rise in global temperature to 1.5°C, because a rise of 2°C created considerable risks for certain countries.

The participating states agreed that greenhouse gas emissions would have to be massively reduced in order to achieve this goal. Net greenhouse gas emissions were to be reduced to zero in the period from 2045 to 2060. It would also be necessary to remove some already emitted CO<sub>2</sub> from the atmosphere. In order to achieve an average global temperature rise of less than 1.5°C, a consistent climate protection policy must be implemented immediately. In essence, this requires the complete cessation of the burning of fossil fuels by 2040, which will likely result in a complete conversion of the global energy supply to renewable energy sources.

The bases for the reduction of greenhouse gas emissions are the voluntary minimum commitments made by the contracting states in their respective Intended Nationally Determined Contributions (INDCs). The stated climate targets are to be adjusted from

2025 and then every five years onwards, with their respective contributions to greenhouse gas reductions being as ambitious as possible and going beyond the efforts of the individual states so far. Contracting states are to submit climate protection plans, which are also to be reviewed every five years and adjusted if necessary. In Germany, the goals and implementation measures of the Federal Government are laid down in the Climate Action Plan 2050. Another goal is climate change adaptation and mitigation; the contracting states have undertaken to submit national adaptation and mitigation implementation plans.

In order to verify the achievement of objectives and compliance with obligations, consistent supervisory authorities are to be set up. A regular measurement, reporting and verification system is envisaged.

To finance climate action globally, it was agreed that the industrially developed countries will provide financial support to less financially-strong countries from 2020 to 2025. A total of USD 100 billion annually was agreed upon to help with climate change adaptation and mitigation.

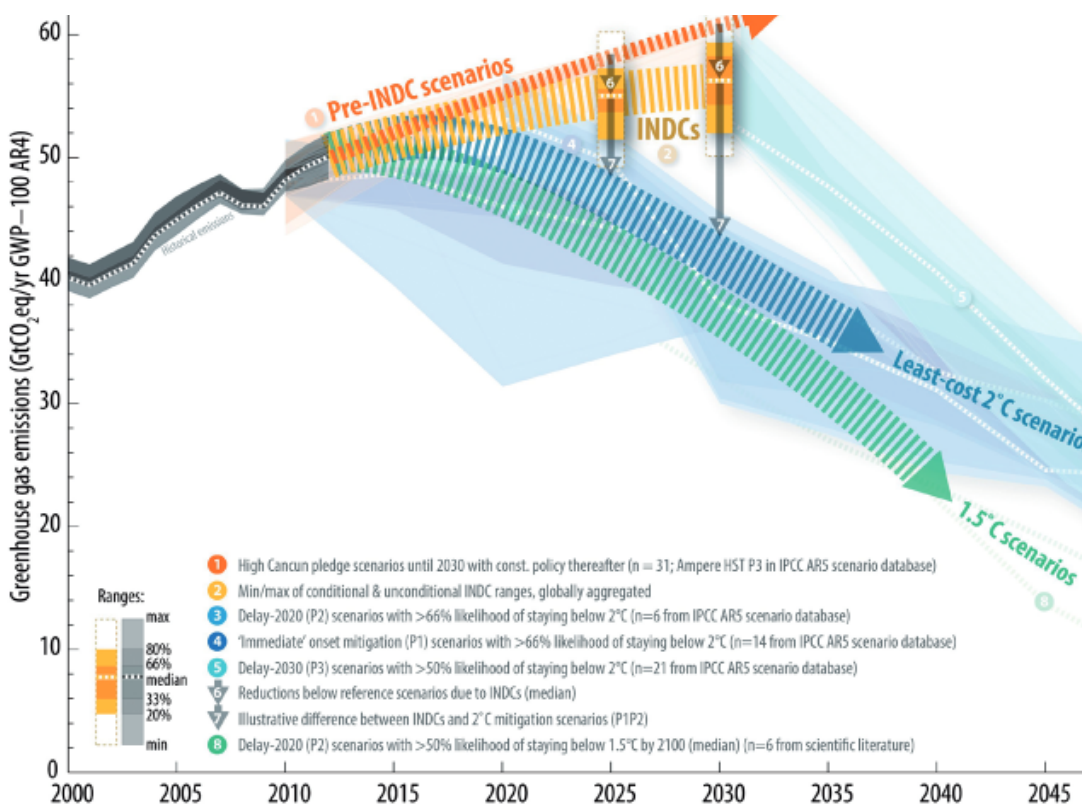


Figure 2.2.1: Development of greenhouse gas emissions. | Source: <http://unfccc.int>.

The Paris Agreement on climate protection was signed in April 2016 by 175 states, including Germany, the USA, China and India. It came into force on 4 November 2016, after having been ratified by 55 states, which together account for more than 55% of global greenhouse gas emissions.

To achieve the targets agreed in the Paris Agreement national measures are to be implemented at the level of the contracting states. However, despite an overwhelming broad agreement and clear readiness to act on the international level, it is difficult for many of the contracting states to take precise measures and implement sustainable projects. In this regard, despite all the urgency to act, there is still a long way to go. So far, the INDCs are not enough to keep global warming below the agreed 2 °C target. However, despite some setbacks, such as President Trump's announcement that the US would withdraw from the agreement, the will to achieve the target remains strong.

### **Marrakesch – COP22**

The successful ratification of the Paris Agreement gave impetus to the 22nd Conference of the Parties (COP22) held in November 2016 in Marrakech, Morocco. The German Minister for the Environment, Barbara Hendricks, rightly observed: 'The signs have never been better for the protection of our global climate. Now it is important to follow up words with deeds.'

COP22 discussed the precise measures and projects required for the practical implementation of the objectives agreed in Paris: financing strategies and frameworks for the transparent implementation of greenhouse gas reduction, and a common roadmap for the implementation of the targets up to 2018 was adopted. In addition, 48 countries severely affected by climate change decided to phase out their coal industries completely. Germany and Morocco established a cooperative partnership for the implementation of climate protection goals. Other states – in both industrialised and developing countries – and international organisations have since joined it.

### **Bonn – COP23 and Katowice – COP24**

In November 2017, the 23rd Conference of the Parties (COP23) took place in Bonn, Germany, under the chairpersonship of Fiji, at which further important steps to implement the Paris Agreement were taken. This conference paved the way for the 24th Conference of the Parties (COP24) in Katowice, Poland, which took place in December 2018, which adopted concrete implementation rules for the measures agreed in Paris;

clear guidelines for reporting, monitoring and revising the commitments by the contracting states to reduce their greenhouse gas emissions were approved.

In order to be more ambitious with regard climate protection efforts, it was agreed in Bonn to carry out audits, for 2018 and for 2019, on how far the contracting states have progressed in reducing their greenhouse gas emissions and fulfilling their financial commitments. A new dialogue format ('facilitative dialogue') was agreed; this aims to facilitate stakeholder discussions and exchanges on how far states are progressing with their respective emission reductions, how successes can be achieved, and how the achievement of goals can be improved.

Furthermore, an initiative from various cities and regions organised a large kick-off meeting on local climate protection measures in Bonn. These activities are becoming more and more important as more than half of the world's population is currently living in urban areas.

### **USA under Trump – climate protection initiatives pass to states and urban authorities**

International cooperation and actual implementation in participating nations is decisive for achieving the goals agreed in Paris. In this context, it seems rather anachronistic that the world's largest producer of greenhouse gases, the USA under President Donald Trump, would refuse to accept the international responsibility this implies and announce its intention to withdraw from the Paris Agreement.

However, while the USA might be in retreat on the federal level, the individual states, and city and local governments, are becoming increasingly important with regard to climate protection policies. On this level, measures are being implemented on the basis of state laws which promote the expansion of renewable energy and greenhouse gas emissions reductions; this not only contributes to the improvement of the global climate, but is also seen as strengthening local economies. One hopes that these initiatives, which stem from the mainstream of US society, will compensate for the reluctance at federal level and that the USA can live up to its global responsibility with regard to reducing greenhouse gases.



## European Union (EU)

In the European Union, the implementation of climate protection policies is progressing comparatively well. The climate protection targets set out in the EU's 2020 Climate and Energy Package were a 20% reduction of greenhouse gas emissions compared to 1990 by 2020, a 20% share of renewables in energy production, and a 20% increase in energy efficiency.

EU-wide agreements have been made to implement these goals. At the same time, regulations and directives to be incorporated into the national laws of EU member states have been adopted. According to estimates by the European Environment Agency, these climate protection targets will not only be met but exceeded.

As part of climate and energy policy up to 2030, the European Union has set itself three further main objectives, based on a decision of the European Council of October 2014:

- Greenhouse gas emissions to be reduced by 40% compared to 1990 levels; this is also a binding minimum target for the member states
- Energy generated from renewables is to be increased by 27% by 2030
- Similarly, energy efficiency to be increased by at least 27% by 2030, and by 30% if necessary.

In order to achieve the climate protection target agreed in the Paris Agreement to keep the global temperature rise below 2°C, greenhouse gas emissions in the European Union are expected to decrease by at least 80% by 2050.

Europe is making good progress in generating energy from sustainable renewable sources. The same applies to the field of energy efficiency, and it is hoped that the self-imposed targets are achieved by 2030. However, the biggest challenge remains the desired reduction in greenhouse gas emissions. Here, especially in the mobility sector, great efforts need to be made to reach the target.

The reform of the Renewable Energy Directive proposed by the European Commission as part of the so-called EU Winter Package is intended to promote the economically viable expansion of renewable energy. The governance of the Energy Union is intended to ensure the achievement of the EU's climate protection goals. A restructured electricity market, which is a feature of the Energy Union, should enable the opening up of

Sector	1990 (Millions of tonnes, CO <sub>2</sub> equivalent)	2014 (Millions of tonnes, CO <sub>2</sub> equivalent)	2030 (Millions of tonnes, CO <sub>2</sub> equivalent)	2030 (Reduction in % compared to 1990 levels)
<b>Energy industry</b>	466	358	175 - 183	62 - 61%
<b>Buildings</b>	209	119	70 - 72	67 - 66%
<b>Transport</b>	163	160	95 - 98	42 - 40%
<b>Industry</b>	283	181	140 - 143	51 - 49%
<b>Agriculture</b>	88	72	58 - 61	34 - 31%
<b>Sub-total</b>	<b>1,209</b>	<b>890</b>	<b>538 - 557</b>	<b>56 - 54%</b>
<b>Other</b>	39	12	5	87%
<b>Total</b>	<b>1,248</b>	<b>902</b>	<b>543 - 562</b>	<b>56 - 55%</b>

Table 2.2.1: German Climate Action Plan 2050 sector targets. | Source: The German government's Climate Action Plan 2050.

national electricity markets and facilitate the better integration of renewable energy. Another key element is a reform of European emissions trading.

The German government is relying on 'technology neutrality' (not specifying which technology is used to achieve objectives) and openness to innovation. There should be open competition so that the best ideas and technologies for achieving greenhouse gas neutrality win out. Renewable energies and/or energy efficiency shall become the standard for investments in the future. By initiating early structural changes in the direction of a greenhouse gas neutral economy, Germany's global competitiveness the field of environmentally-friendly technology can not only be maintained, but further strengthened.

Some standardisation has already occurred in the manufacture and construction of renewable energy generation facilities. Electricity generation from renewables has made significant progress over the past decade, with Germany contributing significantly to this development. Starting with the expansion of power generation from biomass, onshore wind turbines and photovoltaic systems, which was promoted and facilitated by the Renewable Energy Sources Act (EEG), offshore wind turbines are now being manufactured and installed on a large scale. Power generation technology using renewable energy is – based on current knowledge – already very mature. Global manufac-

turing capacities and competition pressure have led to a massive drop in prices for newly-built renewable plants. As a result, electricity from renewable generation has become competitive with conventionally generated electricity. The potential for the development of new technologies is seen by the Climate Action Plan 2050, for example, in new energy-storage technologies, in improved industrial processes and in 'carbon capture and utilisation' (CCU). Another sector currently being restructured is the entire mobility sector. This sector can contribute significantly to the achievement of climate protection goals via hybrid and electric vehicles through to different patterns of transport use.

Although respective objectives have been set for individual sectors, they cannot be considered in isolation from one another. Rather, the different sectors and the interactions between them need to be treated as a whole in order to increase energy efficiency and reduce greenhouse gas emissions. Such sectoral linkages – so-called 'sector coupling' – apply in particular to the three energy-intensive areas of electricity production, heat supply and mobility as well as to energy-intensive industries (an integrated energy approach). Another element of the German Climate Protection Plan is international cooperation with regard to greenhouse gas reduction and the further development of international emissions trading.

Additionally, Germany is now considering the gradual phase-out of coal from power generation by 2038 at the latest. The respective legislative and executive measures remain to be discussed and implemented.

## **Germany – Climate Action Plan 2050**

The objectives of the Paris Agreement and EU climate protection and energy policies have had a direct effect on Germany's climate protection policy. Here, too, the target triad applies: reducing greenhouse gas emissions, expanding renewable energies and increasing energy efficiency.

The climate protection policy principles and objectives of the German government are summarised in the Climate Action Plan 2050, which was adopted in November 2016. This made Germany one of the first countries to draw up a long-term strategy for climate protection and submit it to the United Nations, as provided for in the Paris Agreement of 2015.

The long-term goal is to reduce greenhouse gas emissions by 80% to 95% below 1990 levels by 2050. This goal, adopted by the German government in 2010, is confirmed in the Climate Action Plan 2050. In the medium term, greenhouse gas emissions are to be reduced by at least 55% below 1990 levels by 2030. In order to remain competitive in a world which is moving in the direction of greenhouse gas neutrality, a fundamental restructuring of the economy of the Federal Republic of Germany, the economically strongest EU member state, is required. The economic sectors which will be affected are in particular the energy supply industry, the use and management of the building stock, the transport sector, all of industry, as well as agriculture and forestry.

### **Emissions trading**

International emissions trading, a type of ‘cap and trade’ scheme, originated with the Kyoto Protocol in 1997 and came into force in 2005. Under such a scheme, each participating country is allocated a fixed quantity of emission permits (allowances, also called emissions rights certificates), and when it has used them up but wishes to keep emitting greenhouse gases it may purchase certificates from a country that has exceeded its emissions reduction targets under the Kyoto Protocol. In addition, emission allowances can be earned by a country by taking emission reduction measures, such as reforestation, or sponsoring emission reduction projects in other countries.

Emissions trading is a market-based instrument for achieving a global reduction of greenhouse gas emissions. If the right to emit greenhouse gases into the atmosphere is given a price, and the price is high enough, this acts as an incentive for market actors to take measures to reduce emissions out of economic self-interest. The European Emissions Trading System (EU-ETS) is a key instrument of the European Union's climate protection policy. EU emissions permits have been traded since 2005, and today cover around 45% of European greenhouse gas emissions in 31 countries. Different emissions ‘caps’ and partly different rules were set up during the different trading periods under the scheme.

During the first (2005 – 2007) and the second trading period (2008 – 2012), national allocation plans (NAPs) set the total amount of permits issues and how they were to be allocated. Emission permits were allocated to the participating facilities/industries on the basis of their previous emissions. In the second trading period, not all emission permits were allocated free of charge, some had to be purchased by the power plant operators.

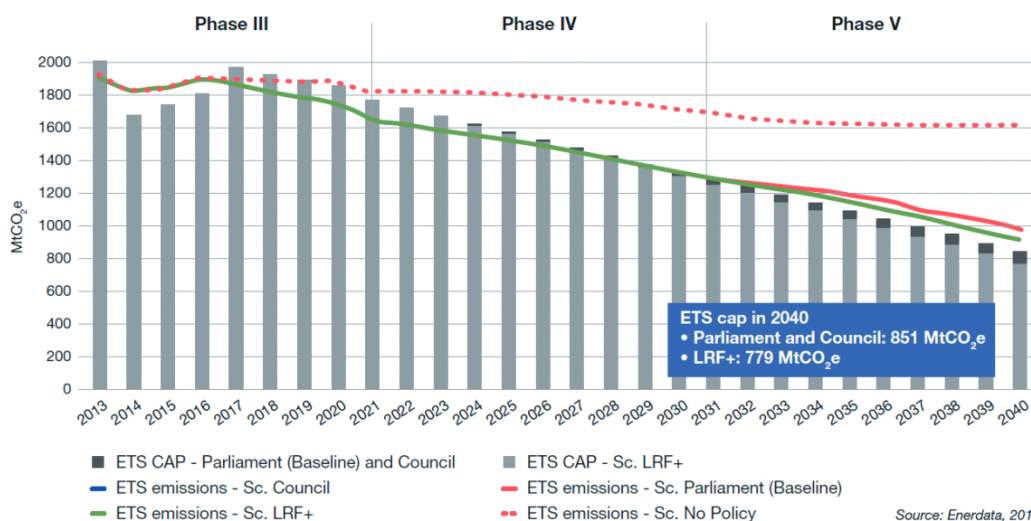


Figure 2.2.2: Total 'caps' and emissions in the EU emissions trading scheme. | Source: Enerdata, 2017.

In order to ensure an EU-wide level playing field, emissions trading in the third trading period of the scheme (2013 – 2020) has been more harmonised and centralised. In addition to CO<sub>2</sub>, other greenhouse gasses were included, and emission limits have been set for the production of certain products. Furthermore, an EU-wide cap was introduced setting upper limits of permissible greenhouse gas emissions by industrial facilities/ industries covered by the scheme. In addition, uniform EU-wide rules were introduced, making the allocation of permits no longer based on historical emission values, but on benchmarks set for the relevant industry. The amount of permits available across the EU is reduced by 1.74% year by year. Furthermore, a large portion of the permits will no longer be awarded free of charge but will be auctioned off to companies participating in the scheme. For a transition period, there is still a free allocation of emission permits for industrial sectors that are subject to particularly strong international competition. At present, around 11,000 industrial plants in energy-intensive industries and in the energy sector participate in emissions trading. The aviation industry has been involved in the scheme – for intra-European flights – since 2012.

If a company performs below its emission level allowance through emission reduction measures, the emission permits 'not used' can be sold on the market. If a company cannot meet its emission reduction targets and exceeds its specified emission allowance, it must purchase emission permits on the market. This makes it economically attractive for companies to reduce emissions.

However, the system assumes that the price of emission permits is sufficiently high to motivate the parties participating in the scheme to reduce their emissions. This requires a reasonable limit on the quantity of permits that are available. If there are too many surplus permits on the market, their price will be low.

At present, there is such an oversupply of emission allowances on the European market that prices have fallen significantly. Measures adopted in 2015 to temporarily discontinue issuing emissions permits (backloading) did not immediately result in the hoped-for effect (higher prices for permits). Therefore, the European Emissions Trading Scheme will be subject to further restructuring in its fourth trading period (2021 – 2030).

The objective of this restructuring is to achieve the 40% emission reduction target set by the EU for the year 2030. As part of achieving this, the total amount of emission permits will be reduced by 2.2% per year each year from 2021 onwards. The principle of auctioning permits will remain. Industrial sectors which face strong international competition will continue to receive a free allocation of permits in order to prevent the relocation of production facilities abroad; however, the number of favoured sectors will be greatly reduced. The so-called Market Stability Reserve (MSR), which was set up as early as 2018, is designed to balance supply and demand for emission permits and to avoid an excess of supply on the market.

It remains to be seen whether these mechanisms will make the European Emissions Trading System a successful model. If it is successful, not only could the EU emission reduction targets be achieved, but the scheme could also serve as a model for other regions of the world. In any case, all countries need to work together to massively reduce greenhouse gas emissions and keep the global temperature rise below 2°C. The road is still long, but the first steps have been taken. It is important that current joint efforts to achieve this goal be intensified.

## 2.3 Incentive mechanisms

*Thomas Schubert*

### Overview

The expansion of renewable energy production is one of the major elements for reducing greenhouse gas emissions and thus counteracting climate change. However, it is not only against the background context of developing a sustainable energy industry that energy generation from renewable energy sources such as sun, wind and water is attractive. Thanks to improvements in efficiency due to technological progress and the drop in prices associated with the increase in production capacities for hardware, electricity generated by renewables has in many places already become competitive with electricity generation from fossil fuel burning power plants. It thus makes sense economically, even without taking emissions reduction into account, to switch to renewable power generation.

In addition, renewables are increasingly being used for decentralised (and off-grid) electricity generation. This enables flexible power supply strategies and electricity to be supplied in regions which would otherwise be without electricity or rely on diesel generators. With the growth and further development of electricity storage technologies, this trend towards decentralised power generation through renewables will certainly increase.

Nevertheless, certain state support measures were or are still required for the market introduction and expansion of renewables. A variety of incentive mechanisms have been introduced in many countries around the world. These mechanisms are structured in many ways. Alongside feed-in tariffs for electricity generated by renewables, and the granting of tradable 'green energy' certificates, support mechanisms also include tax benefits, government support for project financing and direct state subsidies. Projects can also be supported by governments taking on project risks, such as 'project development risks' (in which the government may provide a fully permitted site to mitigate such a risk), which would otherwise be borne by project developers. Covering grid-connection costs with public funds and the granting of grid feed-in priorities for renewables can also have a strong and subsidy-like incentive effect.

There are many parallels in countries around the world with the support mechanisms contained in the German Renewable Energy Sources Act or the EEG (German: *Erneuerbare-Energien-Gesetz*), initially enacted in 2000. The general approach to introduce renewable generation into a market seems to be to start with a fixed feed-in tariff and/or issuing

tradable certificates for the production of energy. Then, when the market has reached a certain maturity, auction-mechanism models – usually referred to as renewable energy auction schemes – are introduced for larger scale projects. At a subsequent stage, this may lead to renewable electricity generation becoming fully merchant and competitive, so that electricity generated from renewables is sold without any sort of subsidy mechanism. Some of the support mechanisms which are used for sustainable electricity production are described in more detail below.

### **Feed-in tariffs (FITs) and feed-in premiums (FIPs)**

With feed-in tariffs (FIT), the owner/operator of a renewable generation plant receives a legally predetermined fixed price per unit of electrical energy generated over a certain time period. This form of remuneration is usually associated with an offtake guarantee. This means that the plant or system owner has the legal right to sell all the electricity generated at the stipulated price to the electricity grid operator(s), who is legally obliged to purchase it.

Prices received usually differ depending on the technology (e.g. solar, wind, biomass) and the size of the system or the plant. The larger the system or plant is, the lower the investment costs required per installed generation capacity; thus, the guaranteed prices paid for the electricity generated are accordingly reduced. Prices may also differ depending on the region where the plant is installed, so that climate differences (wind speed, solar irradiation levels) in a location may be taken into account. The duration of remuneration schemes usually extends over a period long enough to ensure that the owner of a system or plant can recoup the total investment costs and make a reasonable profit. As regards the price to be paid under a support scheme for the electricity generated, this can remain the same over the entire period of the support (e.g. 20 years in Germany applying the EEG), or, alternatively, prices paid are higher at the beginning and gradually reduced over the lifetime of the asset – an example of the latter is the so-called ‘compression model’ (German: *Stauchungsmodell*) used in the EEG to support the development of offshore wind power. Remuneration can be structured in such a way that it is completely decoupled from market price risks; regardless of the market price for electricity, the guaranteed feed-in tariff per unit is always paid.

As an alternative to a fixed feed-in tariff, remuneration can also be designed so that only a premium above the market price for electricity is paid (feed-in premium, FIP); the intention here is to cushion against the additional costs of operating the renewable generation plant. The plant owner is exposed to a certain market risk associated with the



non-subsidised share of the energy price, as a fluctuating market price will affect the final total compensation received. However, the feed-in premiums remain the same.

Legislators can either use technology-neutral mechanisms – stipulate an identical feed-in tariff for each renewable energy technology – or, alternatively, stipulate different feed-in tariffs for different renewable energy technologies and, for example, stipulate a higher feed-in tariff for the more expensive technologies. This enables those technologies which are more desirable from the point of view of legislators to be promoted. For example, the German government initially chose this route using the EEG by setting different tariffs for different technologies. Because these support mechanisms largely or completely insulate system owners and investors from market price risks, the fixed feed-in tariff model is more suitable for the start-up phase of introducing renewables into a market, or for the promotion of smaller systems and plants.

#### **‘Direct marketing’ and ‘market premium’ schemes**

In ‘direct marketing’, the power plant owner/operator bears the risk of finding a buyer for the electricity generated and of selling it at an agreed price. However, the plant operator does not usually sell the electricity directly to a final consumer, but sells it to an electricity trader (also called a ‘direct marketer’), who – depending on the contractual arrangement – assumes the merchandising risk. Nevertheless, the plant owner is exposed to fluctuations in electricity prices and this impacts on the profitability of the generating plant, as this risk is not carried by the electricity trader.

In a ‘market premium’ scheme (also called ‘premium tariff’), renewable energy power plant operators receive a legally guaranteed market premium or ‘premium tariff’ in addition to the fluctuating remuneration they receive from the sale of power on the electricity market. The amount of the market premium may be fixed, or based on a specific pre-determined ‘reference price’. In the latter model, the plant operator is reimbursed for the difference between the wholesale market price (irrespective of whether such a price was actually achieved by the plant operator) and the reference price, in addition to the proceeds obtained from the sale of the power. If the plant operator manages to sell the electricity at a higher price than the average market price through the electricity trader, this will lead to further income. If the electricity is sold at lower than the average market price, the plant owner bears the corresponding losses. Similar to a feed-in tariff, the reference price is based on the costs for the construction and operation of the renewable energy plant and an appropriate rate of return on investment for the owner of the plant.

The UK's Contracts for Difference (CfD) scheme is a similar mechanism. The renewable energy plant operator sells the electricity generated on the market; but via a parallel 'contract for difference' concluded with National Grid plc (the so-called 'delivery body' for the scheme), the plant operator receives the difference between the price at which the electricity has been sold on the market and a reference price (a so-called 'strike price') per generated kWh. If the market price is below the reference price, the difference is reimbursed to the plant operator. If the market price is higher than the reference price, the plant owner must reimburse the surplus amount. As a result, the plant owner thus receives a fixed price per unit of electricity generated and delivered to the offtaker.

### 'Green certificates'

So-called 'green certificates' are an incentive mechanism used, for example, in the UK. These are issued to selected renewable energy generating facilities on the basis of units of electrical energy generated from renewables. The certificates are tradable and can be later withdrawn from circulation (redeemed) once they have been consumed in fulfilment of a 'renewable energy obligation' (an obligation to offset the emission of greenhouse gas emissions by purchasing certificates).

In order for these green certificates to have a monetisable value for renewable energy plant owners, there needs to be a market demand for them. This demand may be created, for example, by obliging operators of conventional energy production facilities or other greenhouse gas emitters to purchase a certain number of green certificates to 'compensate' for the emissions they cause. The price that the holder of green certificates can get on this market is highly dependent on the volume of the demand for the certificates. In particular, the volume of demand must be kept in line with the expansion of renewable energy generation facilities eligible to receive certificates, otherwise there would be an excess supply of them. As with emissions trading, an oversupply of certificates would lead to a drop in their prices, and the incentive effect intended by the state would thereby diminish.

Because the framework conditions for supply and demand are created by the government, the market for green certificates is very sensitive to regulatory intervention. Renewable energy plant operators therefore not only bear the market price risk for the electricity generated; but also, the additional price risk associated with the green certificate market, through which they must be able to obtain additional remuneration.

## Renewable energy auction schemes

In all the renewable energy incentive mechanisms described so far, the prices for energy sold are more or less legally fixed by legislators, though usually with different prices for different technologies and power plant sizes.

However, in mature markets, at least for large-scale plants, competitive ‘renewable energy auction schemes’ (a competitive tendering process) are commonly used. In Germany, starting in 2015 and broadly introduced since the EEG 2017 came into force, renewable energy auction schemes are used for wind power and PV plants from 750 kWp upwards. Renewable energy auction schemes can be designed in different ways. For example, the state may set the amount of the generation capacity that can be bid for as well as maximum bid prices. Furthermore, the question of at what stage of development – in terms of project phase (concept or design), permitting status, etc. – a project must be in order to qualify to take part in the auction will have an impact on competition conditions. Another influencing factor would be the fines which may be imposed on a bidder in case of non-construction of a power plant.

The evaluation of bids and the allocation of contracts – and corresponding financial support for the project – can be executed in different ways. For example, by applying the ‘pay-as-bid’ principle, a successful bidder is awarded the amount of financial support it bid for. If, in the same batch of contracts being auctioned, other bidders who made the next higher bids have also been successful in the auction, they receive the financial support they have bid for without the bid price for the other (lower) bidders in this batch being increased. A further method is termed ‘uniform pricing’; here, the amount of financial support granted is the same for all successful bidders in the batch, and its level is determined by the highest successful bid in the batch.

The aim of renewable energy auctions, from the point of view of policymakers, is to reduce the cost of electricity fed into the grid via a competitive mechanism and thus reduce the cost of supporting renewables. In Germany, if the renewable energy plants that were successful in the 2017 and 2018 competitive auctions are built, this will lead to a considerable reduction in the level of public funding required; in 2017 the ‘reference prices’ (i.e. the bid price of successful bidders) for the lowest successful bids were 3.5 euro cents per kWh for wind power, 4.29 euro cents per kWh for PV plants, and in the offshore wind sector a total of 900 MW of capacity to be installed was allocated without any financial support being provided (0.0 euro cents per kWh). In 2018 bid prices awarded in the auctions were at a similar level.

However, it should be noted that in Germany the grid network operator is obliged to provide the grid-connection facilities and therefore the renewable plant owner is exempt from these costs – unlike in other European jurisdictions. Furthermore, the low bids should also be seen in the overall context of the total generation capacity put to auction, as well as the number of projects which are at a sufficiently advanced stage of development to qualify for participation in the auction. Because the projects will only have to be completed in a few years' time, the bid prices will have taken into account future technological developments, associated increased efficiencies, and the expected reduced construction costs. It remains to be seen what effects the changeover to this auction process will have on manufacturers of plant components and on plant developers/operators, because the increased competition and cost pressure will certainly lead to a considerable consolidation of the market.

### **Merchantability of renewables**

Electricity generation from renewables has become competitive with that from newly-built conventional power plants in many countries, and is well on the way to becoming competitively priced elsewhere. Subsidies, by means of fixed or variable feed-in tariffs, will therefore no longer be required in the near future, at least not for large-scale plants. As a result of this development, the operators of renewable energy plants will have to face market price risks when selling electricity onto the electricity market themselves or through direct marketers. This new volatility in revenues from electricity sales will undoubtedly affect the financing structures for renewable generation projects, which until now have been geared to comparatively stable and reasonably calculable revenue streams.

Alternatively, market price risks can be mitigated by concluding long-term power purchase agreements (PPAs) in which a bulk purchaser undertakes to pay a certain fixed price for the electricity generated by a renewable plant. In particular, due to the expected future expansion of energy storage capacities, which can ensure a constant energy supply from renewable energies, the use of PPAs and similar arrangements will increase in importance.

#### References

- /1/ US Energy magazine July 2017.
- /2/ <https://de.wikipedia.org/wiki/Sektorkopplung>.
- /3/ Weltenergierat Deutschland 2018: Energy for Germany – Facts, Perspectives and Positions in a Global Context | 2018.
- /4/ BWK, Erneuerbare Energien Special 7/8 – 2018.

## 3 Technologies

### 3.1 The renewable energy mix

*Atom Mirakyan, Stefan Drenkard*

In order to achieve the climate protection targets, the highest possible share of renewable energy (RE) and associated technologies should be used for electricity and heat generation. To date, wind and solar power are the most significant contributors in Germany – alongside hydropower, biomass and biogas. However, wind energy and solar energy are not always available when they are needed. A mixture of different electricity generation technologies is always needed to compensate for the spatial discontinuities (renewable resources are not available at all locations) and temporal discontinuities (intermittency) of renewable energy sources, and to ensure supply security. Necessary are also additional measures, such as energy storage (e.g. pumped-storage power plants, battery storage) and demand side management, helping to match times of high energy consumption with times of high availability of wind and solar energy. In different countries, different energy mixes have emerged corresponding to local conditions, historical developments and the availability of different renewable sources. Under favourable conditions in some countries, sufficient energy supply from other renewable sources, in addition to wind and solar energy, is permanently available to ensure supply at all times, such as hydroelectric power in Norway or geothermal energy in Iceland. In other countries, fossil-based power plants (gas, coal) are currently being used for this purpose. The goal is to reduce the share of fossil fuels in the overall energy mix.

To achieve an optimal renewable energy mix, several issues play a crucial role, such as security of supply, economic and ecological goals, network availability and adequate provision of balancing energy. The following strategies can be used:

1. *Utilisation of different sources of energy:* generation of electricity from several energy sources, such as solar, wind, hydro, biomass, biogas; this contributes, among other things, to increasing security of supply.
2. *Utilisation of different technologies:* for example, the combination of hydropower plants with pumped-storage power plants; the utilisation of different technologies, in conjunction with the appropriate economic and ecological framework conditions, improves the security of supply from renewable energy plants.

3. *Utilisation of technologies at different locations where electricity is produced at different times:* the goal here is to match electricity production with demand patterns at targeted locations/regions and times. This could include, for example, installing wind farms in different locations with complementary expected wind regimes.
4. *Demand side management:* influencing consumer behaviour so that demand better matches with supply availability.

Which strategy leads to the best result depends on the local energy generation options and demand patterns. Public consultations can be helpful, for achieving public acceptance of the optimal mix.

In Germany, the future power generation mix will be dominated by wind power and photo-voltaic systems – alongside a smaller share of hydropower and other renewables. A study by the Fraunhofer Institute [1] concluded that for Germany a mix of approximately 60% wind and 40% photovoltaics (total installed capacity) results in a cost optimised solution. In addition to economic analyses, there are other methods/tools which can be used to estimate an optimal renewable energy mix. The Shannon-Wiener index (H)<sup>1</sup> is used to quantify levels of energy security. The higher the H value, the more ‘robust’ is the supply. Another evaluation criterion used is the concept of the ‘capacity factor’ (the capacity factor of an RE system or plant is the ratio of the actual generated electricity over a given time period to its potential maximum generation if continuously operating on full capacity) Figure 3.1.1 shows the development of the share of electricity generation from renewable sources, capacity factors and Shannon–Wiener index H-values in Germany since the year 2000.

In the past 15 years, the RE share in electricity generation in Germany has been steadily increasing, as has the Shannon–Wiener index H-values as an indicator of security of supply. By contrast, the total capacity factor of renewable energy systems has dropped, which means the utilisation of the renewable energy systems has decreased in relation to their theoretically possible maximum. In the last 7 years, the Shannon–Wiener index H-value and capacity factor have stabilised, while the share of renewables has continued to increase (see Figure 3.1.1).

<sup>1</sup>The Shannon–Wiener index (H) is a statistical method used to estimate the diversity of a whole system with individual participants. The more energy sources making the same energy contribution are involved in the entire energy supply, the more homogeneous and secure the energy supply. The value of H is calculated as follows:  $H = -\sum_i p_i \ln p_i$ , where  $p_i$  is the contribution of renewable energy sources  $i$  to the total energy mix.

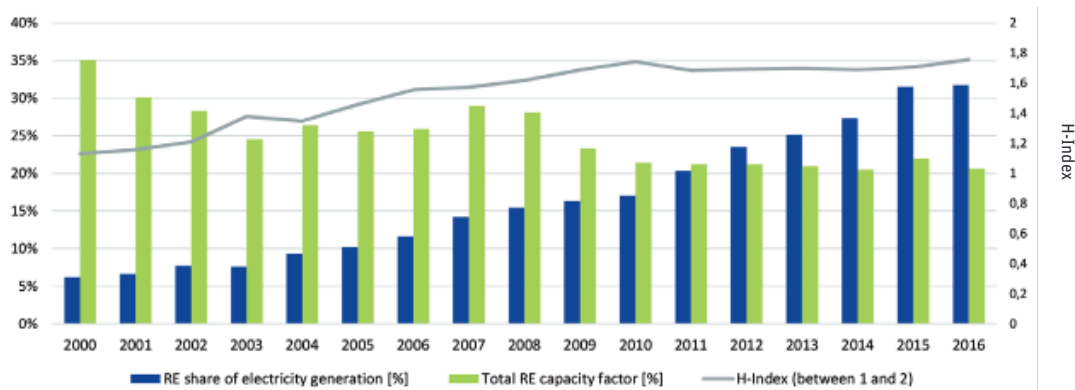


Figure 3.1.1: Development over time in Germany of the share of renewable energy in electricity production, with capacity factors and Shannon–Wiener index H-values. | Source: BMWi, German Federal Ministry for Economic Affairs and Energy, 2018.

Although more data are needed to fully explain the trend, this development may be partly explained as follows: initially mainly RE systems with lower capacity factors (wind and solar) were added to those with higher capacity factors (hydropower), thereby reducing the overall average capacity factor. Over the following few years, conditions stabilised at expected levels or increased slightly with the installation of better systems. Another reason for the stabilisation was the increasing share of biomass or biogas cogeneration plants, which operate with a relatively higher capacity factor and thus contributed to the improvement of the whole renewable energy mix, including capacity factor.

The security of supply solely based on renewable energies in Germany still has to be improved, as renewable energy sources do not yet cover the demand at all times. However, compared to the EU-28 or, for example, the UK, Germany stands in a relatively better position. The H-index for Germany was 1.75 in 2016, while it was 1.68 for the UK and only 1.51 for the EU-28.

The weighting of the various criteria for selecting the optimal renewable mix will change over time – and will depend on technological advances and/or grid expansions. In order to master the challenges of the future, different renewable energy mix strategies are required. The relevant technologies for achieving the highest possible share of renewable energy are discussed in the following chapters.

### 3.1.1 Solar thermal – heat production

Wolfgang Streicher

Buildings have been heated ‘passively’ via solar radiation for millennia, and they still are. The absorption of solar energy by the building’s structural mass is generally not actively controlled – except partly, in some cases, via shading mechanisms; and the release of thermal energy into living space is not regulated at all. The entry of solar heat into the building depends on the position of the sun, the weather, architecture, and shading structures; its retention in the building depends on the thermal storage and insulation potential of the building’s construction materials. (This is called ‘passive solar’; ‘active solar’ refers to solar systems which involve the use of mechanical and electrical equipment.)

Even in central Europe, where solar irradiance on a horizontal surface averages 800 – 1,200 kWh/m<sup>2</sup> per year, conditions for the passive use of solar energy are favourable. On the average summer day this is 5 kWh/m<sup>2</sup> per day. On an average winter day, it is only one fifth of that (1 kWh/m<sup>2</sup> per day). In winter, on a vertical south-facing façade, it is 1.6 kWh/m<sup>2</sup> per day; the sun is low in the sky and thus almost perpendicular to the façade. But in summer, on a south-facing façade, despite the much longer days, because the sun

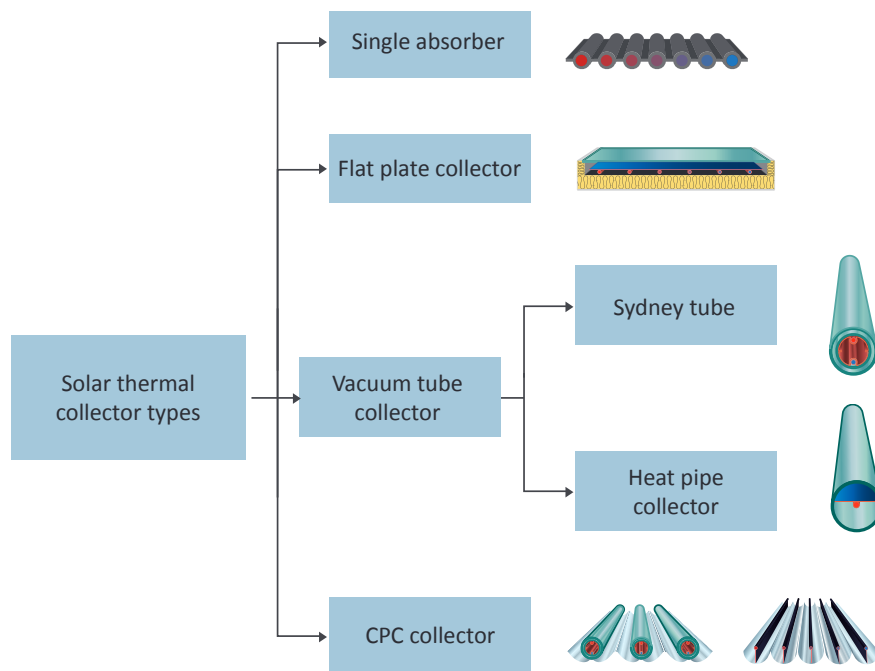


Figure 3.1.1.1: Different solar thermal collectors. CPC refers to compound-parabolic-concentrator collectors. | Source: Fa. SOLID, Graz, Austria.





Figure 3.1.1.2: Solar thermal collectors. | Source: RENAC.

is generally higher in the sky and the angle of incidence is low, it is 2.6 kWh/m<sup>2</sup> per day. Thus, south-facing façades are well suited for the passive use of solar energy.

In northern Europe, solar irradiation levels are lower, especially in winter, and the difference between summer and winter is greater than in southern latitudes. The highest annual solar irradiation levels in the world are in the desert areas north and south of the equator, with over 2,300 kWh/m<sup>2</sup> per year; here, seasonal variations are low.

The maximum intensity of solar radiation (in terms of power) in clear, cloudy and dust-free skies is about 1,000 W/m<sup>2</sup>, regardless of location. ‘Solar thermal’ generally refers to solar energy-harnessing systems by which solar energy is absorbed by a solar thermal collector and transferred via a heat transfer medium to perform work (the application). The solar collectors, together with their necessary system components, are called a solar thermal system. Such systems convert solar radiation into heat which can be used in a large number of different applications, such as for domestic water heating, for swimming pool water heating, for space heating, to produce process heat for industry, and to power cooling systems. The efficiency of a solar collector is defined as the ratio of heat it exports relative to the solar radiation it is exposed to. It depends on the collector design and the temperature difference between its heat absorber and the ambient temperature (where the solar collector is situated). When the temperature difference between the two

increases, heat losses from the collector increase – and efficiency decreases. Thus, for solar collectors to work efficiently, they need to operate at temperatures that match the ambient temperature as closely as possible. How much of the solar radiation energy is harnessed and performs useful work depends on a large number of parameters: quality of the system and its installation, installation angle and orientation, system operating temperature, ratio of collector size to storage systems size to heat demand, hydraulics and control systems, etc. The best way to design systems is to use computer software that can simulate annual system performances in hours or even minutes, and which allow the decisive parameters to be changed, as well as providing a choice of climate data.

The three most common types of solar collectors are flat plate, vacuum (or evacuated) tubes and the type used to heat swimming pools. The latter are unglazed and have no insulation. However, for this application, they have a very high efficiency, because they usually operate at only slightly above ambient temperatures, which means heat losses are low. Flat plate collectors are suitable for when the difference between the temperature of the water being heated and the ambient temperature is up to 80°C; though in some cases, they are also used for higher temperature differences, but then they have a second glass pane or an insulating underlay film. Vacuum tube collectors are particularly efficient with even higher temperature differences. At lower temperature differences, they usually operate at efficiencies lower than those of flat plate collectors. Solar water heating accounts for 94% of the world market for solar thermal. 68% of systems are in single-family houses; 26% are larger plants; solar heating systems for swimming pools account for 4%; and solar combisystems – which provide hot water and central heating / space heating – account for only 2%, though they are quite common in central Europe.

In recent years, a new development has emerged: due to the increasing share of renewable energies in the electricity mix and the associated decreased electricity production costs, comparatively expensive gas-fired combined heat and power (CHP) plants are being shut down. On the other hand, for example in Denmark, the use of large-scale solar thermal plants, which can produce heat at a low cost of less than 0.04 € per kWh to support district heating networks, is proving to be a rapidly growing market.

At the end of 2017, the world's largest large-scale solar thermal plant, with 156,700 m<sup>2</sup> of collector area, was commissioned in Silkeborg, Denmark [7]. Systems that produce low-temperature process heat are also being increasingly installed. Solar thermal cooling systems using adsorption or absorption heat pumps are technically possible and, in 2015, about 1,350 systems had been installed globally [5]. Because high levels of solar radiation generally occur at the same time as cooling is required, solar thermal cooling

has potentially a large field of application. However, the substantially higher investment costs of these types of systems compared to the cost of photovoltaic-operated systems with compression heat pumps means that these types are presently only economically viable if operated at near-full capacity for long periods of time, and if other services (hot water, space heating) are simultaneously supplied. Therefore, the market share of solar thermal cooling is so far very small. At the end of 2016, there were approximately 652 million m<sup>2</sup> of solar thermal collectors installed worldwide, with a thermal output of around 456 GW and a useful energy yield of 375 TWh per year [4]. Globally, China leads with a market share of more than 70% of total installed solar thermal capacity; an estimated 309 GW was installed there in 2015 and about 30.5 GW additional capacity is being installed each year. In Europe, flat plate collectors are mainly used; in China, mainly vacuum tube collectors. Solar thermal technology is used very differently in different regions. Globally, simple 'passive' systems (thermosyphon, without pumps) for water heating dominate the market (systems with pumps are called 'pumped' systems). These are often available inexpensively in many countries with high solar irradiation levels and, as a result, are quite widespread.

Total solar thermal collector area installed in Germany at the end of 2016 was around 19.9 million m<sup>2</sup>; this corresponds to a total output capacity of around 13.9 GW. In terms of average energy yields, the approximately 2.24 million systems installed in Germany produce slightly more than 13.9 TWh per year of usable low-temperature heat. However, from a technical point of view, the potential is 10 to 15 times this [6]. Most of the collector systems that have been installed in Germany in the past are small plants with collector areas of under 10 m<sup>2</sup>. Since the year 2000, however, there has been a growing trend towards installing combisystems, both in single-family house and apartment blocks, which accounted for 58% of the market in 2010. There are a number of commercially-available compact combisystems, as well as a large number of more customised systems (built with individually-sourced components) [3].

Since 2010, the market for solar thermal systems in both Germany and Austria has been declining, which has already led to some company closures. This is due not least to the sharp decline in prices for photovoltaics and, at the same time, only slightly lower prices for solar thermal systems. This probably means that the prices of solar thermal systems will need to come down in the future if they are to compete successfully with photovoltaics. In China, 'passive' solar water heating systems produce heat at 0.04 € per kWh; in Austria, where 'pumped' systems are used, the price is 0.17 € per kWh. However, larger plants (>50 m<sup>2</sup>) can produce heat at almost the same cost of approximately 0.08 € per kWh in both Austria and China. In the case of very large-scale plants (several 1,000 m<sup>2</sup>),

heat production costs in Europe can fall below 0.04 € per kWh [4]. And with the growing trend towards so-called ‘zero energy buildings’, it remains to be seen what proportions of building surface areas will be covered by solar thermal and photovoltaics in the future [3] [4] [5] [6] [7].

### **3.1.2 Solar thermal – electricity generation**

*Oliver Baudson, Jürgen Högrefe, Andreas Wiese*

The term ‘solar thermal electricity/power generation’ describes the following energy conversion process; solar radiation is converted into heat, then converted into mechanical energy in a thermodynamic cycle, and the mechanical energy is used to produce electrical energy. Because the solar radiation that is collected/used by these systems is always concentrated/focused, the different technologies used are also known as concentrated (or concentrating) solar power (CSP).

CSP is different from CPV (concentrated photovoltaics) technology. CPV involves concentrating visible light radiation and is a photovoltaic technology; it does not involve the conversion intermediates – heat and mechanical energy – which are found in CSP plants. CPV technology is not discussed in this chapter.

Solar thermal power generation makes use of only the direct component of solar radiation. This is because the solar radiation is always focused (concentrated), directed, and redirected. The diffuse component of solar radiation cannot be focused (concentrated). Because of this, solar thermal power generation power plants can only be effectively used in regions where the proportion of direct solar radiation is high – which are mainly in the so-called Sunbelt areas of the world.

There are three main types of concentrated solar thermal power plants currently being widely used. The essential difference between them is the type of solar radiation concentration involved. They are:

1. Parabolic trough
2. Fresnel concentrators
3. Solar tower.

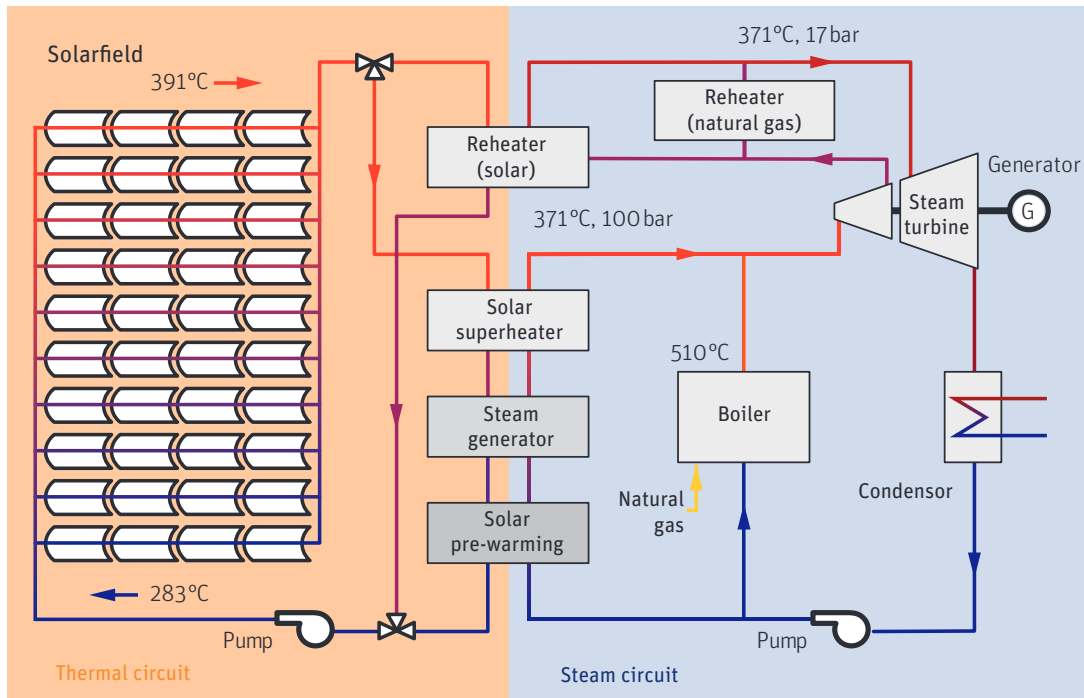


Figure 3.1.2.1: Schematic of a parabolic trough solar thermal power station (SEGS I-IV in California, USA). | Source: *Solarvorhaben – wirtschaftliche, technische und rechtliche Aspekte* by Jörg Böttcher, Oldenbourg Verlag 2011, Germany.

There are also solar parabolic dish systems. This technology is rarely used for large power plants, but it is suitable for smaller power generation units and on uneven terrain; (it is not discussed here).

With all CSP technologies, the energy conversion chain consists of the following steps (see also Figure 3.1.2.1):

- Collecting/focusing solar radiation with the help of a mirror system (heliostats, Fresnel lenses, parabolic mirrors)
- Concentrating/focusing the solar radiation onto a 'solar receiver'
- Converting the solar radiation energy collected by the solar receiver into heat
- Transmitting the thermal energy collected to an energy conversion unit (evaporator) and/or to a large-scale thermal energy storage system (e.g. molten salt) in order to be able to use the solar energy collected after sunset or during cloudy periods

- Converting the thermal energy into mechanical energy (e.g. via steam turbines, Stirling engines)
- Converting the mechanical energy into electrical energy via an electricity generator.

This energy conversion chain transforms the solar radiation energy collected into electrical energy. Depending on the plant type and the technical design, efficiencies of over 40% in the rated power range can be achieved. In such CSP plants, especially those with energy storage, with a high solar multiple (ratio of thermal solar field power to thermal turbine power) very high area-specific energy yields and comparatively high capacity factors (the ratio of energy actually produced to theoretically maximum producible energy for a specific period of time) can be achieved.

### **Parabolic trough power plants**

Parabolic trough power plants concentrate and focus solar radiation using curved mirrors that focus the sunlight onto a pipe situated along the focal axis of the parabolic mirrors, through which a heat transfer medium circulates. The mirrors track the sun uniaxially (on a single axis). These days, in systems which use oil as the heat transfer medium, temperatures of almost 400°C in the steam turbine can be achieved. In systems which utilise the direct evaporation of water in the solar circuit, or use salt as a heat transfer medium, much higher temperatures can be achieved (560°C). This corresponds to the temperature levels in steam turbines used in gas and coal power plants. The world's largest parabolic trough power plant is the Solana Generating Station, in Gila Bend, 110 km southwest of Phoenix, Arizona, USA. Its rated capacity is 280 MW, and it has six thermal storage tanks, whose medium is molten salt.

### **Fresnel power plants**

A Fresnel power plant is similar to a parabolic trough power plant, but the long mirrors are not curved – or only slightly so. The solar radiation is focused linearly onto the solar receivers (heat transfer pipes) mounted above them. Narrower mirrors are used that individually track to the sun and are installed at differing inclination angles, one behind another.

### **Solar tower power plants**

In solar tower power plants, the solar radiation is concentrated/focused by means of flat or slightly curved mirrors (heliostats) to a focal point at the top of a central tower.



Figure 3.1.2.2: Cleaning a solar trough power plant, Kuraymat, Egypt. | Source: Gerhard Hofmann, Agentur Zukunft.

Depending on the size of the power plant, tower heights can be from 30 to over 200m above ground level. The solar receiver, in which a liquid or gaseous heat transfer medium is heated, is situated at the top of the tower. The temperatures achievable are significantly higher than in parabolic trough or Fresnel power plants due to the ‘spot focusing’. As a result, higher overall efficiencies can be achieved. One of the world’s largest solar tower power plants is near Ivanpah, California, USA, which is about 60 km south of Las Vegas in Nevada. It consists of three 140 m high towers and 347,000 mirrors and has a rated output capacity of 392 MW. High-temperature operation, as in conventional energy technology, places high demands on the materials used – research is ongoing on how best to optimise materials.

### Hybrid plants, storage, baseload provision

CSP power plants can be combined with other technologies to form so-called hybrid plants. For example, a CSP plant can be combined with a combined-cycle gas and steam plant to form a so-called ISCC power plant (integrated solar combined-cycle power plant). In these, the steam supplying the steam turbine can be heated by both the waste heat from a gas turbine and by heat generated from the solar system. There have also been recent initiatives which aim to combine CSP technology and PV

technology. In such systems, the advantages of both technologies – the ability to store energy generated by CSP plants and the low costs of PV – are used in a controlled and integrated system. The first commercial CSP-PV hybrid project is currently in the tendering process (Midelt 1/Morocco).

Today's CSP power plants are equipped with thermal storage. This makes use of the good storability of heat. Mostly, molten salt is used as the storage medium. In small-scale plants, water is sometimes used. The use of concrete as a storage medium is still in the development stage.

CSP plants can achieve similarly high annual capacity factors to conventional power plants, and/or can deliver electrical energy into the power grid during times of higher demand. Both of these scenarios increase the economic viability of plants significantly. In the first case, the specific cost of energy production is reduced. In the second case, higher revenues are achieved, because in periods of higher demand, electricity can usually be sold at higher prices. Another advantage of energy storage in CSP plants is that the predictability and security (dispatchability) of the provision of energy and its delivery to the grid is improved. CSP power plants can thus meet grid baseload requirements, and can contribute significantly to grid-voltage stability. Thanks to their energy storage capability, CSP power plants can predictably deliver energy even at night, during cloudy periods or during sandstorms.

### **Market status**

At the end of 2017, well over 5 GW of CSP had been installed worldwide. Most plants are still in Spain. About 2 GW of solar thermal power plant capacity is currently under construction. China plans to have 10 GW of solar thermal energy installed by 2020.

### **Potential – technical and economic**

Technically, the greatest potential for solar thermal power plants lies in the Sunbelt (southern Europe, North and Central Africa, the Middle East, parts of India and China, the South of the USA, Mexico, as well as in individual countries of South America such as Chile) – in short, wherever there is a high level of direct solar radiation.

From a technical point of view, most electrical energy demand can be covered by CSP power plants in these regions. However, this would only exploit a small proportion of the solar potential of these regions. In addition to making these sun-drenched regions



largely energy self-sufficient, excess CSP-generated electric power could be exported to neighbouring demand centres – ideally to regions beyond the Sunbelt. At locations with suitable conditions, solar thermal – electricity generation can now be highly competitive compared to conventional and other renewable power generation technologies. Recently, contracts have been awarded for power plants with electricity generation costs of US \$ 0.073 per kWh. Because increasingly more electricity from intermittent renewable energy sources (wind, PV) is being fed into power grids, another advantage of CSP is currently gaining more and more importance: that, because of its storage capacity, it can easily stabilise power grids. This could open up new market opportunities for CSP – the advantage of its ability to act as a baseload power supplier outweighs the current disadvantage of its slightly higher cost in numerous situations. For these reasons, the economic potential of CSP is today very high in many geographical regions.

### **Future developments**

The prerequisite for utilising the full potential of CSP is, however, the implementation of the following cost-reduction measures over the coming years:

- Increasing plant efficiencies via, for example, using higher heat transfer medium temperatures and/or the use of salt, not only as a storage medium, but also as a heat transfer medium
- Optimisation of the production of individual plant components
- Further optimisation of overall systems
- Optimisation of operation.

How and which specific technologies will establish themselves on the market is not yet foreseeable. However, current trends suggest that all the technologies described in this chapter will occupy some market segments. Currently, a significant increase in the market share of solar tower power plants can be seen. Mostly, solar tower and parabolic trough power plants will establish themselves for power generation; however, site conditions will strongly influence the choice of technology. Fresnel technology could play an important role in process heat production.

### 3.1.3 Photovoltaics

*Fabian Kuhn*

Photovoltaics (PV) refers to the direct conversion of insolation (incident solar radiation) into electricity. PV solar cells accomplish this with the direct conversion of sunlight. Solar radiation intensity varies considerably depending on the location. In the Sunbelt of Africa, in the Middle East and in Chile, global horizontal irradiation (GHI) reaches values of up to 2,400 kWh/m<sup>2</sup> per year, while in central Europe it is usually around 800 to 1,100 kWh/m<sup>2</sup> per year. PV systems generally fall into two categories: grid-connected (small systems or large plants), and 'off-grid' (systems not connected to the grid), which are typically found in remote regions and on islands. Systems combined with diesel generators (with or without batteries) or other power sources are called 'PV-hybrid' systems. Small off-grid PV systems are also found in the leisure and consumer goods sector; for example, on boats and recreational vehicles or to charge mobile phones.

#### Solar cell technologies

There is a range of different solar cell / PV module technologies. Each has different characteristics and application possibilities.



Figure 3.1.3.1: Examples of PV applications in the leisure and consumer sector. | Source: Pixabay, RENAC.

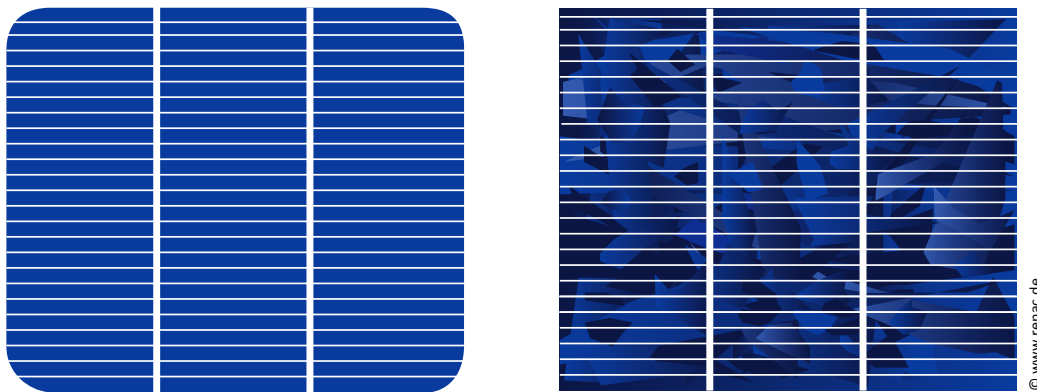


Figure 3.1.3.2: PV module with monocrystalline cells (left), PV module with polycrystalline cells (right).  
| Source: RENAC.

The most widely used PV cell technologies are:

Crystalline silicon

- Monocrystalline silicon (mono-Si)
- Polycrystalline silicon (poly-Si)

Thin film

- Cadmium telluride (CdTe).

Crystalline silicon module efficiencies range between about 16% and 22%. Cadmium telluride thin-film modules have efficiencies of around 17%. There are also other solar cell technologies that play a minor role in the global solar market: amorphous silicon (a-Si), gallium arsenide (GaAs), copper indium gallium (di)selenide (CIGS, CIS); these are not discussed here.

### **PV module mounting structures**

There are two main types of mounting structures for PV modules:

- Fixed mounts oriented towards the south in the northern hemisphere, and towards the north in the southern hemisphere
- Tracking mounts which follow the path of the sun through the sky.

Both types are extensively used and have proven themselves worldwide.

### Land-area requirements for PV plants

The land surface area required for large-scale PV plants is usually between 1 and 2 hectares per installed MWp. It depends on several factors, such as:

- Land area available for a project
- Desired PV system performance rating (Wp)
- Criteria by which the design of the PV system is to be optimised
- Preferred technology and layout options.

A project-specific design considers various parameters and criteria in order to optimise the plant concept. Optimisation can have the following goals:

- Maximisation of installed power and total energy yield (MWh)
- Maximisation of PV plant performance and specific yield (MWh per installed capacity)
- Minimisation of electricity generation costs (euro cent per kWh).

The energy payback period for PV systems depends on the technology used and solar irradiation levels at the system location; it usually ranges between half a year and two years. The expected service life of PV modules and PV systems is at least 25 – 30 years with regular maintenance.

Both large PV ground-mounted and PV rooftop systems play an important role in solar power generation. At the end of 2017, PV installed worldwide reached 415 GWp, of which more than 115 GWp was in the European Union [8]. This development should continue, with installed capacity expected to double by 2020.

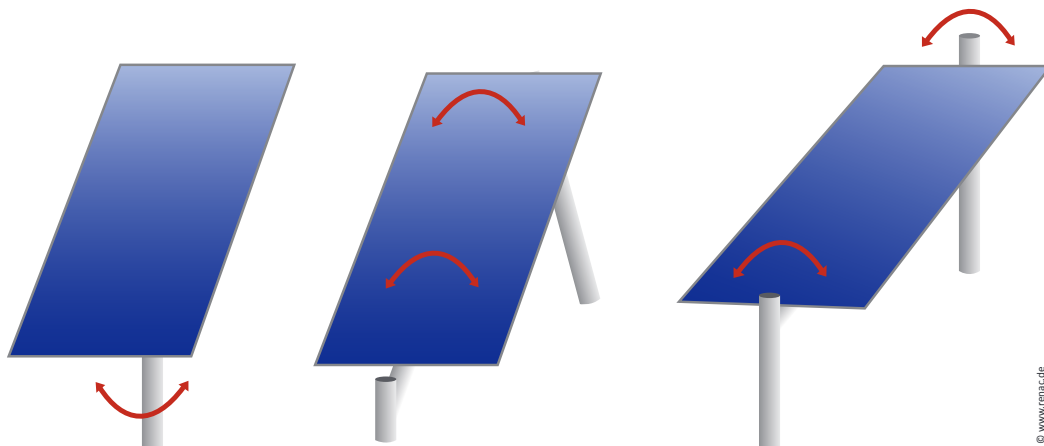


Figure 3.1.3.3: Single-axis tracking PV module mounting system. | Source: RENAC.

### 3.1.4 Biomass

*Heiko Peters*

In Germany, the use of biomass for the generation of electricity and heat has been on the increase for several years. This has been promoted, especially in the case of power generation, by the German Renewable Energy Sources Act (EEG). Other legislation, such as the Renewable Energy Heat Act (EEWärmeG) and the Combined Heat and Power Act (KWKG), has also promoted the increased use of biomass for energy production.

Biomass can be used to generate both electricity and heat, and to produce biofuels. In 2016, a total of 51.6 billion kilowatt hours of electricity, 148 billion kWh of heat and 3.4 million tonnes of biofuels was produced from solid, liquid and gaseous biomass [9].

Biomass was the most important renewable energy source in 2016 in Germany, accounting for around 59% of energy produced from renewable sources. This is especially the case in the heating and transport sectors, where biomass accounted for 88% and 89%, respectively, of final energy consumption from renewable energy sources used in those sectors [10].

The most common biomass raw materials used in Germany are:

- Wood
- Energy plants (plants grown specifically to be used as an energy source)
- Crop and other organic residues.

The main biomass-energy technologies are: biogas plants (fermentation process), biorefineries (producing liquid biofuels), pyrolysis and hydrothermal carbonisation (production of coal substitute). Biomass can also be used directly in heating plants or as a direct source of heat. By far the most important bioenergy source in Germany is the renewable raw material, wood. It is used for heat generation in small incineration plants, in centralised heating plants (for district heating networks), in biomass-powered combined heat and power (CHP) plants, and directly as a fuel for electricity generation.

Wood fuels can be used at efficiencies of more than 90% and they currently account for more than 75% of heat generated from renewable energy sources in Germany. In 2016, 9.1% of German heat energy consumption and 1.9% of electricity consumption were supplied from wood energy. Wood production can be intensified by planting so-called short rotation coppice plantations. Figures for 2014, however, showed that this type of



Figure 3.1.4.1: Rape field in Brandenburg, Germany. | Source: RENAC.

biomass production has not been significantly developed; it is not mentioned in the 2016 German Federal Government Climate Protection Plan.

Alongside forestry, agriculture is an important supplier of biomass through the cultivation of energy crops. The most important of these are:

- Rapeseed for biodiesel production
- Maize (corn), grass and sugar beet for the production of biogas
- Cereal crops and sugar beet for the production of bioethanol.

Germany only requires a small proportion of its agricultural land area for its planned expansion of bioenergy production. It is estimated that by 2020 the area of agricultural land that will be used for bioenergy production will be about 3.7 million hectares [11]. In 2016, approximately 2.4 million hectares were used for energy crop production (0.96 million hectares for liquid biofuel production, 1.5 million hectares for biogas production, and 0.01 million hectares for the production of solid fuels) [12]. Since 2013, the land area used has remained at about 2.4 million hectares. Another increasingly important source of biomass is organic waste. Particularly suitable are:

- Waste wood
- Household organic waste

- Liquid and solid manure
- Cereal straw.

These sources of biomass will be of importance in the future, as the use of waste and residual products enables what is called ‘cascading use’– the efficient use of natural resources, materials, and land – so as to, for example, avoid conflicts between land use for energy crops and for food crops. For example, 100 cattle provide both meat/dairy products, but their manure is enough to supply nearly 30 average German households with electricity. Systemic analysis is required when designing cascading value flow systems for biomass; both ecological and economic aspects need to be considered.

The use of biomass for the coupled generation of electricity and heat – in CHP plants – can significantly supplement solar and wind energy. Biomass is storable and can therefore be used for both electric-grid baseload coverage and as an energy carrier. Electricity generated from biomass can contribute to grid stability.

Biogas can also be fed into the natural gas network – after processing into bio-natural gas. This is a further means of storing energy. In Germany, because the available land area is limited and because of competing land-use demands, biomass availability is limited. This means that the resource needs to be efficiently managed – which includes taking nature conservation and environmental issues into consideration.

Biomass use must therefore take account of overall demand requirements, efficiency criteria, and the use of other renewable energy sources. So-called material flow-oriented strategies are recommended; these include taking into consideration the avoidance of emissions, the availability of other organic waste, wastewater issues, avoiding unnecessary energy use through the more efficient use of resources, reducing resource consumption overall, avoiding the use of environmentally harmful substances, and increasing the use of recyclable by-products.

Recently, there have been attempts to produce biomass in urban areas, such as on rooftops, facades, traffic areas such as parking lots, roads and tracks for the growing (mega) cities of the world. However, currently (2017) hardly any commercial applications specifically for urban biomass production are known.

### 3.1.5 Biogas plants

Heiko Peters, Heiner Schröder

Biogas technology is important for energy security and the reduction of greenhouse gas emissions. Because of this, but also for other reasons, the number of biogas plants in Germany has considerably increased in recent years. Biogas is produced by the fermentation of organic matter in oxygen-free conditions. During this biochemical process, which is called ‘anaerobic fermentation’, microorganisms break down biomass into smaller chemical compounds. Biogas mainly consists of methane (CH<sub>4</sub>, 50 – 75%) and carbon dioxide (CO<sub>2</sub> 25 – 45%), but it also contains small quantities of hydrogen sulphide (H<sub>2</sub>S), ammonia (NH<sub>3</sub>), hydrogen (H<sub>2</sub>), oxygen (O<sub>2</sub>) and nitrogen (N<sub>2</sub>). The aim of biogas production is to produce a high-energy methane gas that can be used to generate electricity and heat – for example, in CHP plants.

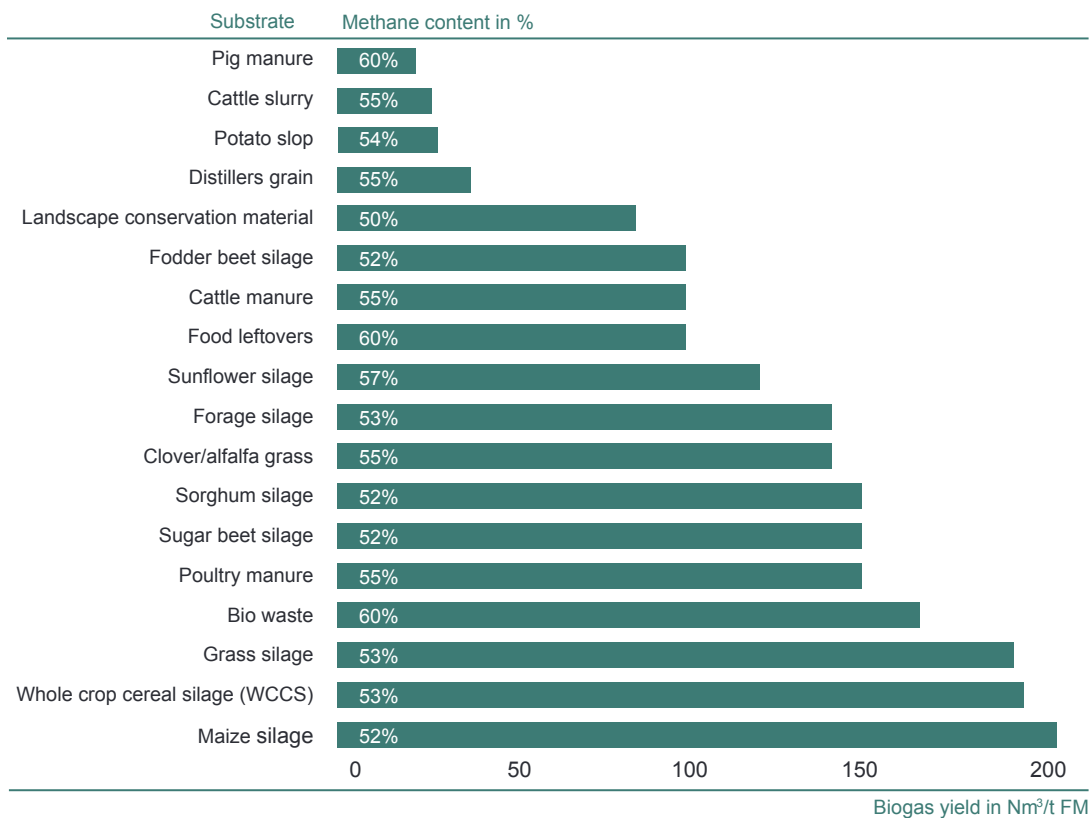


Figure 3.1.5.1: Biogas yield according to substrate in Nm<sup>3</sup>/t FM – FM means ‘fresh matter’. | Sources: FNR 2015, KTBL 2015. | Graphic: RENAC.





Figure 3.1.5.2: A biogas-producing anaerobic digestion plant. | Source: RENAC.

## Substrates

Easily degradable biomass material (called ‘substrates’) are required for anaerobic fermentation – mainly fats, oils, sugars and starches. Biomass with high levels of lignin, cellulose or hemicellulose, such as straw or wood, is less suitable for biogas production.

In Germany, the main substrates used in agricultural biogas plants are energy crops. In 2015, approximately 52% of the substrates, in terms of mass, used in biogas plants were energy crops. The most important energy crop in Germany is maize (corn), because it is the most efficient crop in terms of energy produced per land area used. Perennial ryegrass, grass, sugar beet, sweet sorghum, Jerusalem artichokes and *miscanthus* are also suitable for use in biogas plants. Other increasingly important sources of substrates are organic residues/by-products – agricultural residues such as cattle and pig manure, livestock bedding and crop residues, organic waste from industry, and materials from landscape conservation work. The sustainable development of these potential substrate sources will be particularly important in the future. Energy recovery from organic residues and waste materials enables optimal cascading use, which helps to avoid conflicts between the use of biomass as an energy source and as a material in its own right. The by-product of biogas production (fermentation residues) can be used as fertiliser. Thus, everything produced is used in a closed, natural, material cycle.

## Quantities of biomass produced

The type of substrate used influences the fermentation process and determines the quantity and quality of the biogas produced. In order to achieve high process stability and a high biogas yield, biogas fermenters must be fed substrate of uniform quality and operated at optimum and constant temperature conditions. The choice of operating temperature level depends on the substrate used, on how long the substrate will be in the fermenter, its gas generation potential and on the heat-use concept. Careful operation of the biogas plant also determines the gas production rate in the fermenter.

## Biogas use

Biogas is the most important renewable energy source alternative to natural gas. Currently, in Germany, biogas is mainly converted directly into electricity and heat in CHP plants (usually on site, on the farm). In the future, in order to increase the efficiency of biogas plants, energy-use optimisation will need to be in the foreground. This means that the waste heat generated by biogas plants also needs to be exploited as much as is possible, either via district heating networks or directly at the site of the biogas plant. If this not possible, biogas can also be upgraded to biomethane of natural gas quality, and fed into the natural gas network, and thus used either directly as a fuel or in CHP plants. The natural gas network can also be used as an energy storage system and thus improve energy supply security. In Germany, the network consists of around 530,000 kilometres, thus making it an ideal storage and transport medium for biogas.

## Biogas and the reduction of greenhouse gas emissions

The production of biogas requires only a relatively small amount of fossil energy resources (for fertilisers, planting, harvesting, transport and processing of energy crops). Compared to power generation with natural gas, electricity production from biogas requires 80 to 85% less fossil fuel input. This comparison only takes electricity generation using biogas into consideration. However, because electricity from biogas is generated in CHP plants, heat is also generated, which reduces fossil-fuel use further. Generating electric power with biogas emits 90% less greenhouse gases than generating electricity with lignite (brown coal) or anthracite; power generation with natural gas emits 75% less. In 2016 in Germany, greenhouse gas emissions of around 20 million tonnes of CO<sub>2</sub> equivalents were avoided by the use of biogas – more than 12% of the greenhouse gas emissions avoided through the overall use of renewable energies.

This contribution of biogas to the reduction of greenhouse gas emissions can be significantly increased by further expansion of biogas production and with increased use of organic waste and other suitable organic residues. According to the German Agency for Renewable Resources, because of the amount of biomass available, a significant expansion of biogas production by 2020 is easily possible. From 2014 onwards, this expansion has been / will be based on the use of residue materials (liquid manure and organic waste), mainly because increases in feed-related or substrate-related remuneration (e.g. for maize, sugar beets and cereals) are not anticipated.

### 3.1.6 Wind energy – onshore and offshore, and its connection to the grid

*Henry Och*

‘In 2016, the wind industry in Germany has repeatedly demonstrated its capability with a consistently high level of wind energy being installed on land and at sea. Thanks to technological advances, highly efficient machines which can be easily integrated into the grid could be installed in all regions of Germany.’ This is how the German Wind Energy Association summarises the current situation. ‘Land-based wind energy is *the* most economical energy source. In recent years, a considerable learning curve has been experienced. Higher electricity yields and increased operating hours have both



Figure 3.1.6.1: Transporting a transformer substation for a wind farm in the North Sea. | Source: Dr. Born - Dr. Ermel GmbH.

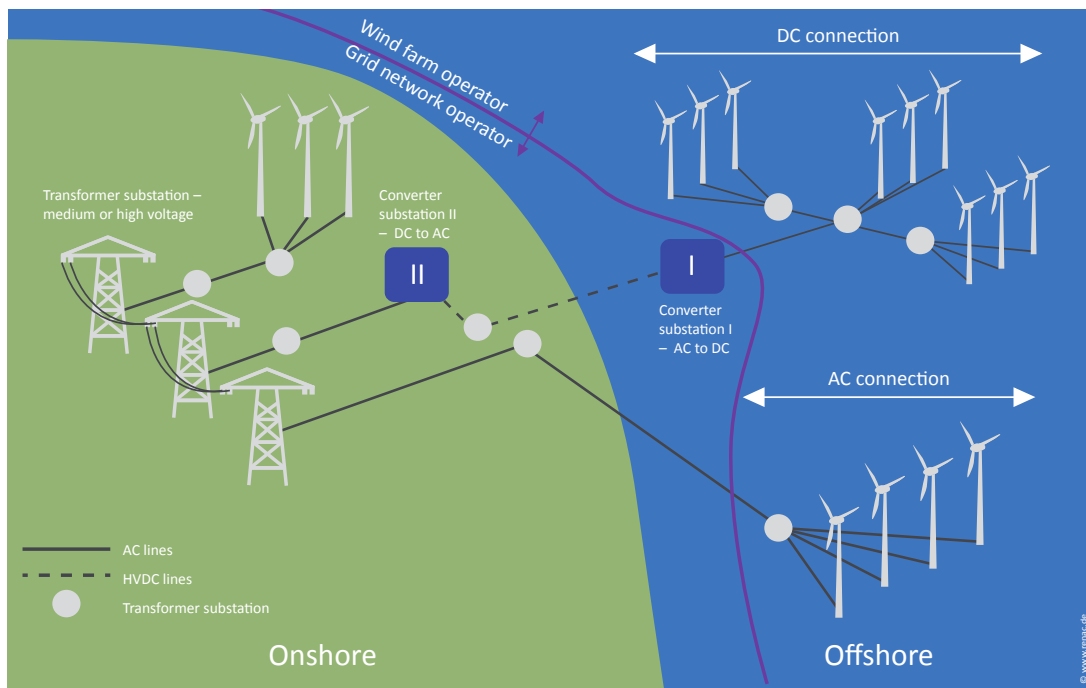


Figure 3.1.6.2: Onshore and offshore wind farms and connections to the grid. | Source: Dr. Born – Dr. Ermel GmbH. | Graphic: RENAC.

compensated for falling remuneration levels under the German Renewable Energy Sources Act (EEG) and contributed to grid stability. The wind energy industry is taking on the challenge of competitive tenders in Germany as well as internationally.’ [14] In the offshore sector, 947 wind turbines with a total capacity of around 4.1 GW have been installed in 16 offshore wind farms in the North Sea and the Baltic. By 2020, 6.5 GW of wind-turbine capacity will be installed offshore. By 2030, this is expected to reach about 800 MW per year. Already, approved offshore wind farms are almost enough to meet the 2025 target of offshore capacity of 10.75 GW [15].

The German government and the EU have set a definite target for 2050: a reduction of greenhouse gas emissions by at least 80% compared to 1990. [16] Wind energy will make a significant contribution to achieving this. Wind power already makes a considerable contribution to the German renewable energy mix: around 33% in 2016 [17].

But although the use of wind power for power generation has increased significantly in recent years, its potential is far from exhausted [18].

Forecasts regarding further wind power expansion differ according to various studies, but the target for 2030 is up to 25 GW for the offshore sector. Onshore wind energy will

also be significantly expanded. The planning of wind farms in designated priority areas is carried out in conjunction with public consultations. At existing locations, older plants can be replaced with more modern, more powerful wind turbines. Offshore wind also offers further expansion options. The installation of offshore wind turbines near the North Sea coast is not possible due to the intertidal zone there known as the Wadden Sea, so North Sea turbines need to be installed relatively far out at sea.

The advantage of offshore wind is that sea winds are more constant. However, marine environmental conditions are a serious challenge, as is connection to the national electric grid. Electricity from offshore wind farms is converted into high voltage (AC) at substations at sea. The output of several wind farms is then converted to DC voltage on an HVDC (high voltage direct current) sea-based platform and transmitted to the shore using submarine cables. On the land side, the energy is then either converted (at locations in different regions) to AC voltage and routed to the consumers, or it is transmitted over an HVDC line to the south of Germany. In order to put future project funding on a competitive basis, auction/tendering mechanisms were included in the German Renewable Energy Sources Act (EEG) in 2017 for both on and offshore wind turbines and these will come into operation from 2021 onwards. Only companies who have been awarded a contract via these tendering procedures will be then be able to connect to the national electric grid.

### **Wide spectrum of engineering tasks**

Designing, planning and installing an offshore wind farm differs considerably from planning and installing an onshore wind farm. International regulations for the certification of offshore wind farms must be observed. Substations at sea are normally operated unmanned; all of their systems must be fully automatic and, in the event of a malfunction, capable of being made safe. In addition to actual power transmission, fire protection systems, air conditioning, emergency generators, land-based monitoring and control, beacons and warning lights, and other intelligent systems need to be designed and installed. Other areas of focus for engineers include seabed soil assessment, steel construction issues, foundations, logistics and the laying of submarine cables. Nature conservation and environmental protection requirements also need to be met. And there are health and safety issues, careful planning for commissioning, and the actual operation of the turbines and associated maintenance tasks.

Northern Germany has greater potential for both onshore and offshore wind energy than southern Germany. So, the challenge is to provide consumers in western and southern Germany with electrical energy from the north via high-voltage and extra-high voltage lines as well as underground lines which incur only the lowest possible line losses. Network expansion of all voltage levels is necessary to ensure long-term and sustainable quality of life and prosperity. Engineers must ensure feasibility, compliance with regulations and sustainability. Connections and routes in the extra-high, high and medium-voltage grids need to be planned and implemented.

The task of consulting engineers is to turn ideas into reality in compliance with national and international regulations, and to standardise individual services as far as is possible. And last but not least, how effectively and speedily they can implement projects is dependent on government policies and the legal frameworks in place.

### **3.1.7 Geothermal**

*Ingo Sass*

The term geothermal or geothermal energy/power refers to technologies which use the heat stored in the Earth's crust. The usual classification is between near-surface geothermal (NSG) and deep geothermal (DG); however, in recent years, medium-deep geothermal has increasingly established itself as a separate field with specific performance profiles. (Note that terminology differs across English-speaking countries, and systems are often also classified according to technology type.) All forms of geothermal energy plants, whether for cooling, heating, heat and cold storage, or electricity generation, are considered as baseload plants capable of producing energy at a constant rate and potentially available on orders of magnitude that are essential for large sustainable energy supply systems.

#### **Near-surface geothermal energy**

Near-surface geothermal mostly refers to harnessing geothermal energy at depths of about 100 to 400 m. At these depths, temperatures up to 25°C are found, which can be used to heat and cool large buildings, such as the German Bundestag (parliament building) in Berlin, and commercial and industrial and infrastructure facilities.

The most frequently used method of extracting heat from geological layers at these depths is via geothermal probes which are inserted into a borehole to extract geothermal

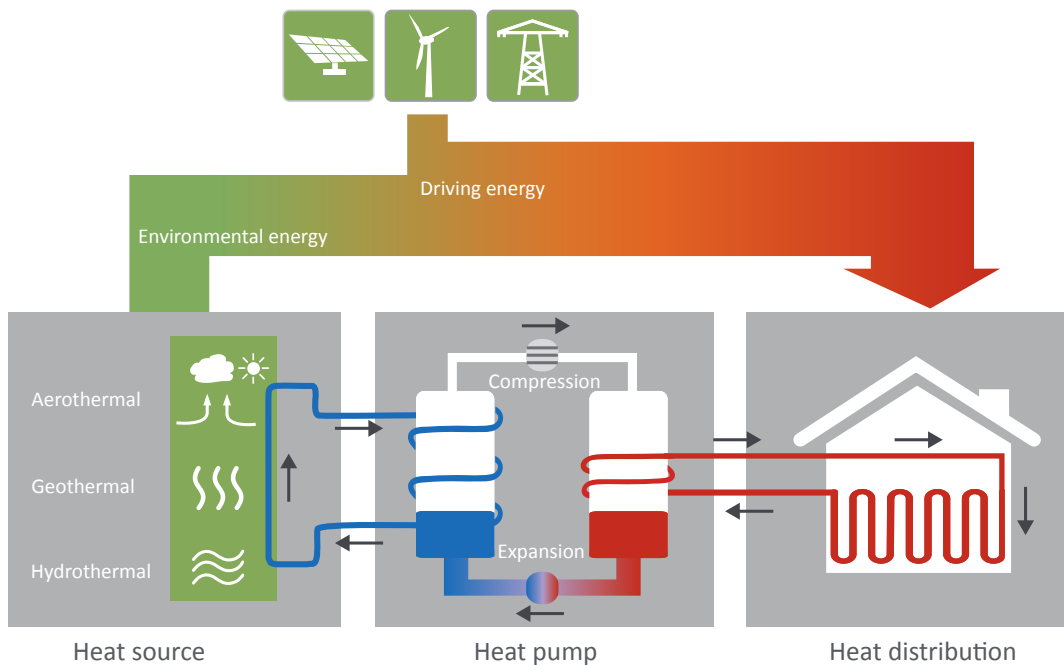


Figure 3.1.7.1: Working principle of a heat pump. | Source: RENAC.

energy from the surrounding soil and rock via conduction, as an alternative to extracting groundwater and exploiting its heat [19]. (Geothermal probes are also called borehole heat exchangers or BHEs, or downhole heat exchangers or DHEs; other terms used are geothermal or underground heat exchangers), In addition to these near-surface geothermal systems that are designed to supply heat or cold – for example, to cool buildings by pumping heat into the ground – several near-surface geothermal storage systems are also in use, and there is now plenty of experience in designing and operating these systems successfully [20]. However, the impact on groundwater resources does need to be critically assessed. The environmental impacts of these systems on groundwater organisms (animals, plants, fungi) are still largely unresearched [21]. Because of this, to date, there is no uniform practice in Germany for approving the maximum permissible levels for groundwater heating [19]. The use of subsoil and rock layers for thermal storage can conflict with water management and environmental protection requirements. This can result in regulatory restrictions with regard to system sizes, operation and permitted expected effects on groundwater temperatures.

Near-surface geothermal systems can be used almost everywhere in Germany – only licensing issues limit their use (see also [22]).

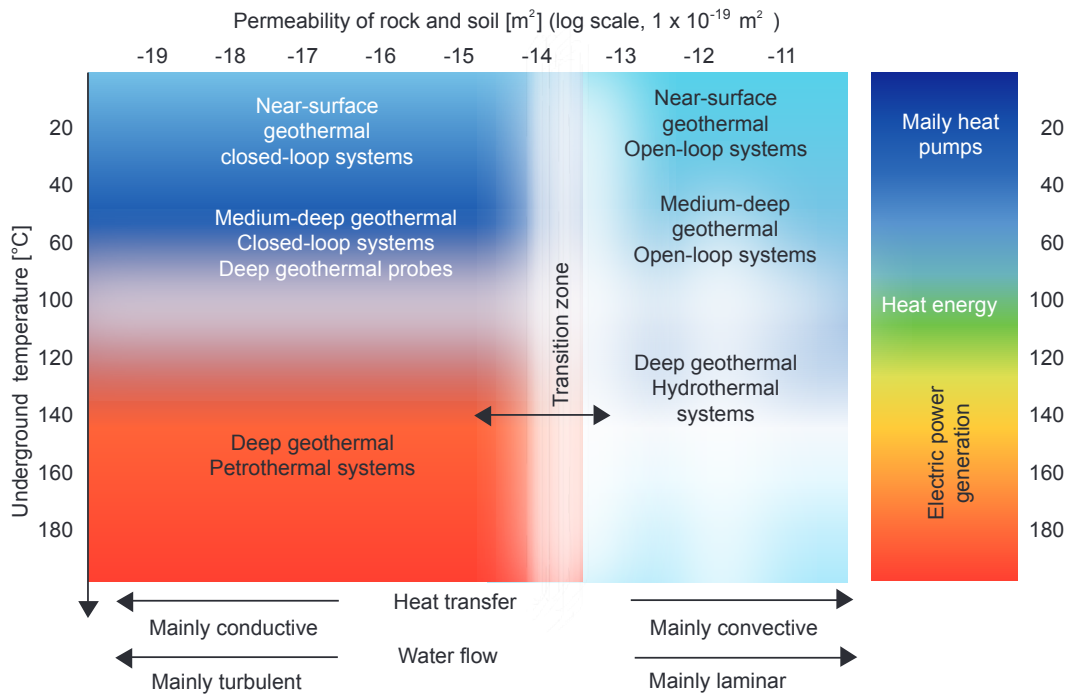


Figure 3.1.7.2: Definition/classification possibilities for geothermal systems based on subsurface permeabilities and depths. | Source: Sass 2012. | Graphic: RENAC.

## Medium-deep geothermal

Medium-deep geothermal combines elements and processes of near-surface geothermal and deep geothermal technology and primarily refers to systems operating in the medium-deep ranges (from depths of around 100 m to 1,000 m). The conventional demarcation line between near-surface geothermal (to depths of 400 m) and deep geothermal (depths of greater than 400 m) is no longer in line with current technological developments. The successful use of flat drilling technology at depths of more than 400 m has already been demonstrated. Boreholes (or geothermal wells) that were up to now considered ‘deep’ are now being equipped with the types of borehole heat exchangers (BHEs) and heat pumps that have previously been typically used in near-surface geothermal systems [23]. This type of geothermal can be described as medium-deep geothermal. Medium-deep geothermal is a technology that uses comparatively deep boreholes to both extract and store heat, but – like near-surface geothermal – is not suitable for generating electricity. From the point of view of possible applications, medium-deep geothermal differs from near-surface geothermal by the higher temperature levels available (see Figure 3.1.7.2). Today’s drilling methods enable the economically viable drilling of geothermal boreholes to a depth of several hundred



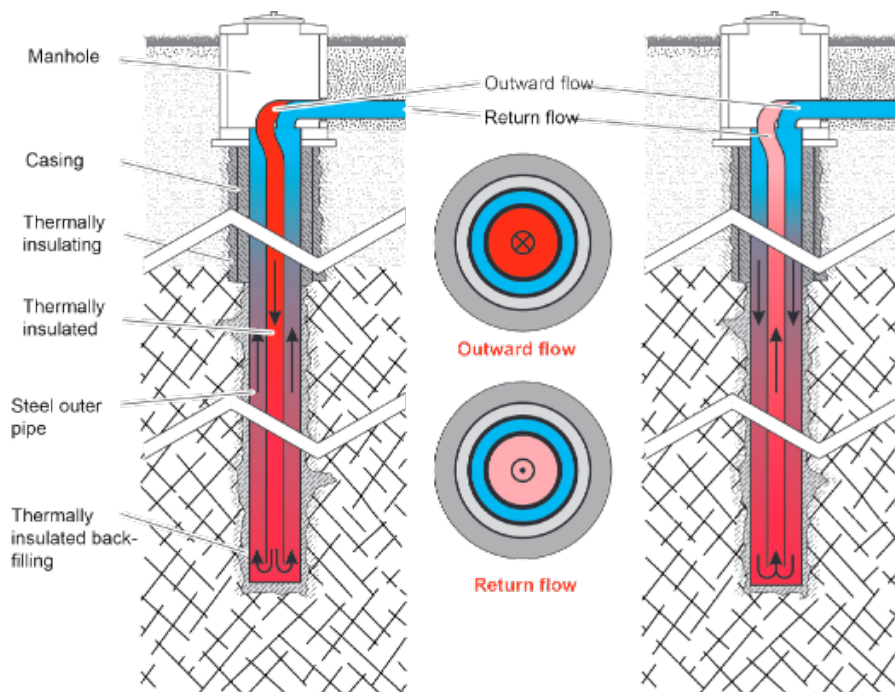


Figure 3.1.7.3: Coaxial geothermal probe for use in medium-deep geothermal storage system (left: heat input/loading; right: heat extraction). | Source: Bär et al., 2015.

metres. For example, a 770 m deep geothermal probe has been installed in Heubach in the Odenwald, Germany [24]. The system has the typical characteristics of a medium-deep geothermal plant: a higher utilisable temperature of 18 – 2°C (without storage use) compared to near-surface geothermal, and a coefficient of performance (COP) of 4 – 6.

### Medium-deep geothermal storage systems

A special potential geothermal application lies in the thermal storage properties of rock. Unlike near-surface geothermal, medium-deep high-temperature geothermal seasonal storage does not directly impact on groundwater resources. This thermal storage can take place in the deeper, inanimate bedrock of a groundwater aquifer (see Figure 3.1.7.4). The use of deeper geological layers / rock formations for thermal storage enables much higher heat storage temperature levels than is likely to be achieved in near-surface geothermal storage systems. In addition, the permeability of the bedrock decreases with depth, reducing the risk of groundwater flows enabling stored heat dissipating and leading to thermal storage efficiency losses.

Medium-deep geothermal storage systems consist of geothermal probe fields which, in contrast to near-surface geothermal storage systems, consist of fewer and deeper

borehole heat exchangers. This reduces the surface-area requirement of the system, which makes the technology particularly attractive for use in densely built-up urban areas. Coaxial pipes are typically used for medium-deep geothermal, as opposed to the double-U pipes used elsewhere (see Figure 3.1.7.3), because an outer steel pipe can better withstand rock pressures and the pressure loss of the fluid flowing through them is lower [23].

Underground temperatures increase on average by approximately 3°C per 100 m increase in depth (the geothermal gradient). Therefore, higher temperatures can be reached with medium-deep than with near-surface installations. This reduces the lateral temperature difference and thus storage losses during high-temperature heat storage, at least in the lower section of a geothermal probe. In the upper section of the borehole, thermal insulation is recommended via larger borehole radii and the use of heat-insulating backfill materials. This thermal insulation reduces heat losses and thus increases system efficiency. At the same time, the thermal influence on the near-surface aquifers is also reduced (see Figure 3.1.7.4). Shallow installations may not offer the possibility of protecting the groundwater resources, as the boreholes are often entirely located in the aquifer concerned. To do so would involve thermally insulating the entire

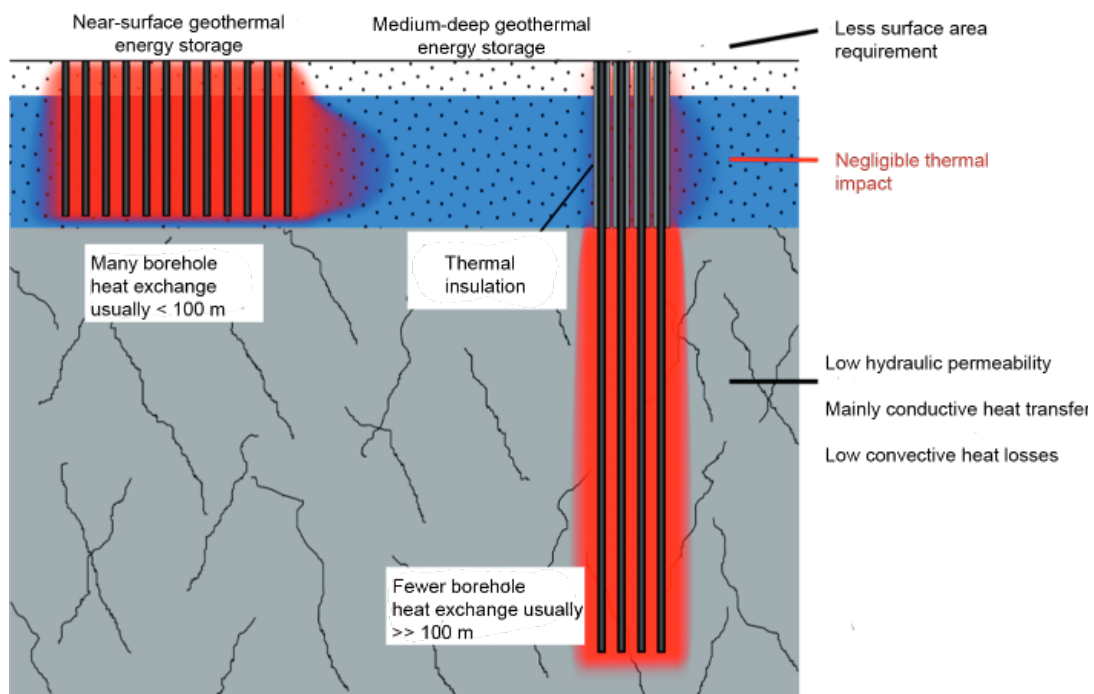


Abb. 3.1.7.4: Schematic comparison of the thermal influence of near-surface and medium-deep geothermal storage systems on an aquifer. | Source: Welsch et al., 2015.

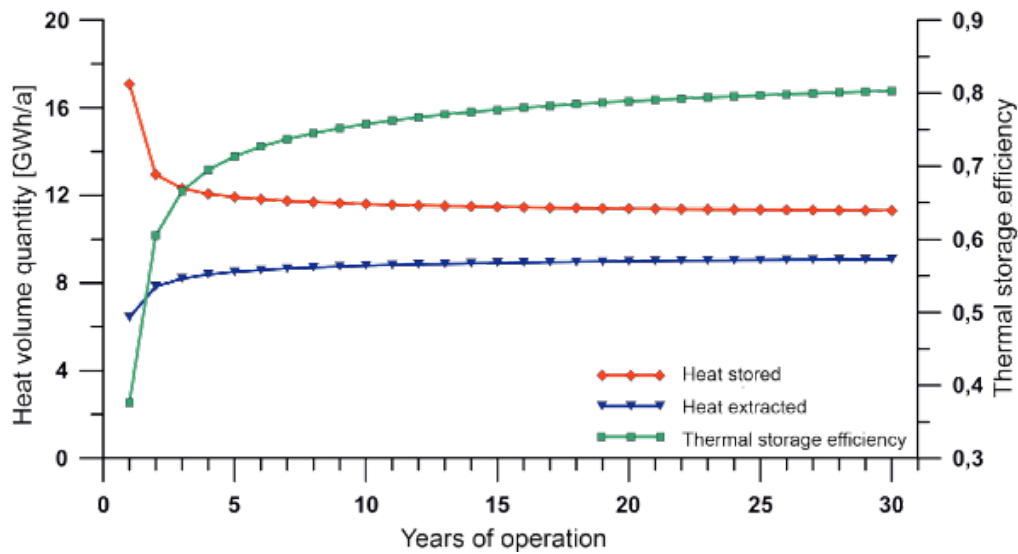


Figure 3.1.7.5: An example of the operation over time of a geothermal storage system (37 geothermal probes, each 500 m long, 5 m distance between probes, feed temperature 90°C). | Source: Welsch et al., 2015.

borehole, which would lead to a significant deterioration in the heat extraction capacity of the system. High temperature storage of heat in near-surface installations can therefore be ruled out.

Additionally, the high-temperature storage of heat at 70 – 100°C increases the underground temperature in the rock. This leads to an increased specific heat extraction capacity (ratio of heat extracted per meter of borehole), which can exceed 100 W/m. Moreover, the heating of the rock results in higher geothermal probe output temperatures – of 20 – 40°C, and in some cases over 70°C. When these systems are used to service low-temperature heating systems, this minimises the remaining temperature rise that is required of the heat pump, and consequently reduces the electrical demand. It may even be possible to operate the heating system without a heat pump. Furthermore, these higher temperatures permit the use of heat pumps that raise the temperature level to such an extent that conventional heating systems with flow temperatures of over 55°C can be used.

With near-surface geothermal systems, the temperature rise required of the heat pump for conventional heating systems is usually too great, obviating the use of near-surface geothermal systems in all but new, highly insulated, buildings. Nevertheless, it does open up possibilities for the use of medium-deep geothermal to provide heat for existing buildings with conventional heating systems that are being renovated to improve their energy efficiency.

The efficiencies and heat extraction rates of different geothermal storage system layouts can be investigated and compared by means of numerical simulation (Figure 3.1.7.5) [26]. In this study, a total of 200 virtual models with different input parameters and different spatial geometries were created and their performance simulated and compared. The length of the geothermal probes, the distance between the geothermal probes, and the number of BHEs were varied. A highly simplified operation scenario made it possible to simulate half-yearly loading and unloading cycles over an operating period of 30 years. The following operating parameters were specified: a half-yearly change of the flow temperatures in the geothermal probes of 90°C during the storage period and of 30°C during the extraction period, and a constant heat exchanger fluid flow rate of 4 l/s per heat exchanger.

While the heat that can be stored per operational year decreases, the longer the system is operated, the greater the increase in the volume of heat that can be extracted. In the first years of operation, this leads to a very sharp increase in thermal storage efficiency. Although this rate of increase gradually declines, a slight increase can still be observed even in the 30th year of operation. These effects can be attributed to a gradual warming of the geothermal storage reservoir. However, the warmer the geothermal storage reservoir is, the less heat can be stored and the more heat can be extracted. The system thus becomes even more efficient after 30 years of operation (see Figure 3.1.7.5).

While the stored and extracted heat quantities show an approximately linear increase with increasing geothermal probe length, the storage capacity varies depending on the distance between the geothermal probes. Under the operating configurations specified in the simulation, the optimum distance between the probes both for thermal energy storage efficiency and for the specific extraction capacity was found to be approximately 5 m, depending on the thermal conductivity and the drillability of the rock. While the thermal storage efficiency successively increases with geothermal probe length, the specific heat extraction capacity shows a maximum with a geothermal probe length of between 300 m and 400 m, and decreases only slightly with increasing depth (see Figure 3.1.7.6).

The thermal storage efficiency increases both with increasing geothermal probe length and with the number of geothermal probes (see Figure 3.1.7.7). Systems with identical total probe lengths show a significant increase in thermal storage efficiency in systems consisting of fewer and less deep probes. The greater the number of probes, the more they can interact with one another. The single geothermal probes thus have a smaller surface area to the unheated underground relative to their volume. The diameter-

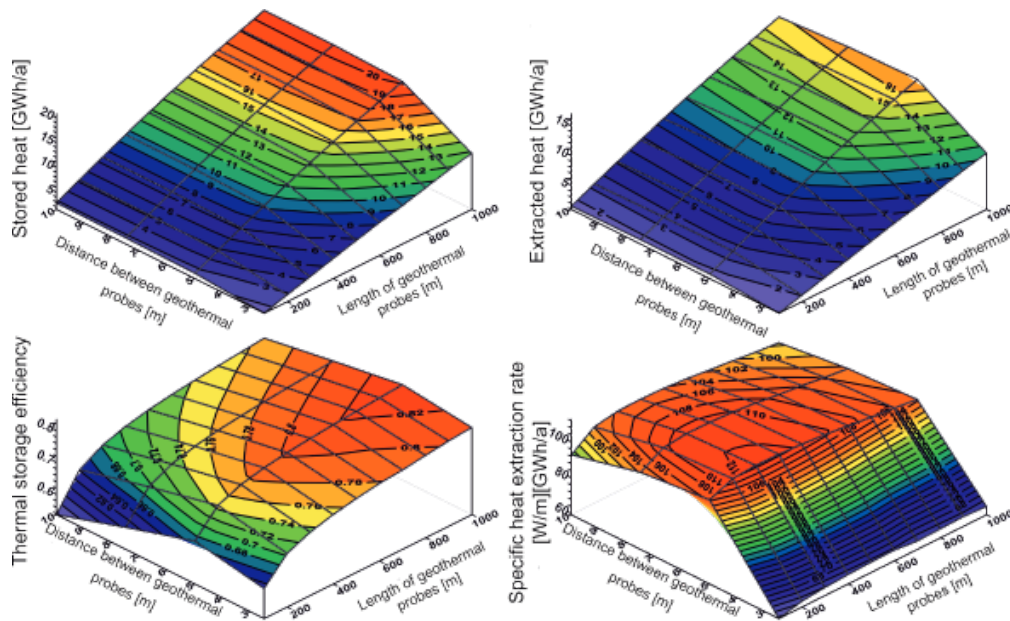


Figure 3.1.7.6: Influence of geothermal probe length and the distances between probes over a range of thermal storage performance indicators, shown for an example system consisting of 37 geothermal probes in 30th year of operation. | Source: Welsch et al., 2015.

depth ratio is a matter of engineered optimisation. With an increasing number of geothermal probes, this increase in efficiency decreases. Systems with only 19 borehole heat exchangers show high thermal storage efficiency of more than 70%.

## Deep geothermal

In deep geothermal technologies, geothermal heat is accessed via boreholes which are usually considerably deeper than 1,000 metres. Even depths of around 5,000 m are not exceptional. Hydrothermal geothermal refers to the use of deep aquifers containing warm (60 – 100°C) or hot (100+°C) water. In Germany, for example, hydrothermal geothermal systems are used, via heat exchangers, to supply local and district heating networks, to provide heat for agricultural or industrial purposes, and to generate electricity. Petrothermal geothermal (see Figure 3.1.7.2) refers mainly to the use of the heat present in layers of rock which have low water permeability or are impermeable. With petrothermal geothermal, low mineral content water is injected into the hot rock at the surface, heated at depth and returned to the surface [27]. In Germany as a whole, the technical potential of usable petrothermal energy is 2 EJ, according to a report by the Office of Technology Assessment at the German Bundestag and recent research. This is two orders of magnitude greater than the hydrothermal potential [27].

Crystalline bedrock with pronounced fracture networks offers favourable conditions for petrothermal geothermal. An open, well-connected fracture network is necessary for hydraulic connections. Under natural conditions, due to low natural permeability only limited water circulation is usually possible. To be economically viable, water flow rates of at least 50 l/s are required, and these can only be achieved in specific locations. Flow rates of 50 l/s and above require higher-permeable geological fault zones. However, there is still considerable need for research in this regard.

System designs therefore concentrate on high pressure injection of water from a wellbore, subsequently widening (stimulating) the fracture network and, if necessary, creating new fractures. This increases the intrinsic permeability of the rock in an area of a few hundred metres around the borehole. Geothermal systems which involve ‘enhancing’ existing fracture networks in rock are called enhanced or engineered geothermal systems (EGS). Following this enhancement work, further boreholes are drilled for the geothermal probes. Water is then circulated through this underground heat exchanger system to absorb the heat.

EGS technology has already been successfully deployed in the Franco-German demonstration project in Soultz-sous-Forêts in Alsace, France. The project shows that an economically-viable use of the deep-rock geothermal resources is possible. In the development of EGS technology, the focus has so far been on electric power generation; though combined heat and power (CHP) generation, which simultaneously generates electricity and provides heat, is also possible. In Germany, the underground source

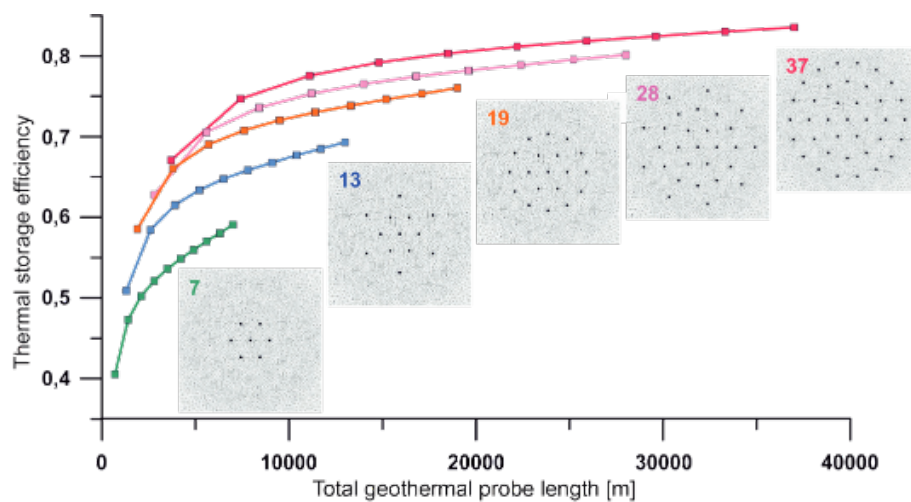


Figure 3.1.7.7: Influence of the number of geothermal probes on thermal storage efficiency, shown for an example geothermal storage system with distances of 5 m between probes in the 30<sup>th</sup> year of operation. | Source: Welsch et al., 2015.

temperatures required for economic viability are around 150 – 220°C. Most regions in Germany have crystalline rock at depths where these temperatures are available, which could be tapped with currently available drilling technology.

With hydrothermal geothermal systems, two boreholes (a double well system) or more are also used. In most cases, one borehole is used to extract hot water from deep underground. Above ground, the heat is extracted from the water and used in a secondary circuit (to distribute the heat to its point of use). After the heat has been extracted, the now-cooled water is infiltrated or most commonly pumped back into the thermal aquifer via another borehole.

The borehole endpoint spacings in the aquifer are determined by numerical modelling using hydraulic test data acquired during the exploratory phase of a project. The aim is to maintain a balance between over-proximity of the boreholes, with associated heat losses ('short circuits'), and unacceptable pressure drops caused by overly large distances. A realistic distance is between a few hundred metres and one kilometre. In principle, a combination of several injection and production/extraction boreholes can be deployed to increase the installable capacity of the overall system, as has been implemented in various projects (in particular, in Molasse Basin in the Greater Munich area in southern Germany). Existing plants can also be expanded in this way.

The decisive factor for hydrothermal geothermal is that the thermal aquifer is capable of delivering high flow rates (at least 30 l/s) and the necessary temperatures. In Germany, these geological layers (with very different characteristics) are found primarily in the limestones and dolomites of the Bavarian and Baden-Württemberg foreland molasses (the South German Molasse Basin, North Alpine Foreland Basin), in the North German Basin and in the Upper Rhine Rift Valley. The current state of exploration varies greatly from region to region and inter-regional comparisons are only possible to a limited extent. The Munich district heating project will be almost totally supplied by geothermal energy during this and the coming decade. However, the geological and engineering parameters for geothermal use in other German regions still need more precise determination via targeted exploration work.

Thermal aquifers are accessed and exploited using modern deep drilling technology. Even in urban and densely settled areas, several directional boreholes can be drilled from one drilling site. The hot water is extracted using submersible motor pumps which are usually suspended at a depth of several hundred metres down the borehole. The big challenge is that, unlike conventional pumps used for oil extraction, these pumps must withstand high temperatures, high flow rates (more than 100 l/s), scales

(precipitates), steam bubbles (cavitation), and corrosion issues. In the past, this has repeatedly led to premature pump failures. Currently, however, pump running times of several years are possible.

In Germany, the construction, technical design and subsequent operation of geothermal boreholes are subject to extensive regulation that serves to protect individuals and the environment. The federal laws covering mining (German: *Bundesberggesetz*) and water-related legislation of the individual states deserve special mention in this regard. All deep geothermal activities that have an impact on the underground environment need special planning permission to operate. This means that from an early stage, when – as is normal – investors and planners know little about the operating conditions, work must be planned in some detail. The entire process is checked, monitored and, if necessary, controlled by the state mining authorities.

In 2017, 24 deep geothermal plants in Germany produced around 895 GWh of heat for local and district heating systems, corresponding to the avoidance of around 200,000 tonnes CO<sub>2</sub> of emissions. Installed geothermal capacity in 2018 amounts to just under 315 MWth – 36 geothermal plants. As regards geothermal electric power generation, heat supply priority plants have established themselves as the preferred option for economic reasons. Electricity is only produced in periods of the year when heat cannot be sold. Nine geothermal power plants in the South German Molasse Basin and in the Upper Rhine Rift Valley, with an installed electrical capacity of just under 35 MWe, produced 160 GWh of electricity in 2017. Overall, the output of deep geothermal plants has increased more than tenfold since the turn of the millennium, and the annual increase since 2010 has averaged just under 20% [28].



### 3.1.8 Hydroelectric power

Reinhard Fritzer

Hydropower – or hydroelectricity – is a renewable energy technology that, in effect, harnesses the sun’s energy. Water from the Earth’s surface evaporates into the atmosphere using heat from the sun. Wind distributes this in the form of clouds, returning the water stored in them to the Earth’s surface in the form of precipitation. If it finds its way into watercourses (streams and rivers) and oceans, its energy can be harnessed and used to generate electrical power.

#### Hydropower – the fundamental physics

Hydropower plants (or stations) typically collect water in a reservoir, behind a dam, from where it is channelled to a lower level where its kinetic energy can either be converted directly into work (for example, to power a sawmill or grain mill) or converted via turbines into hydroelectricity, using an electric generator.

The efficiency of the entire system is calculated by taking into account the energy losses which occurs as water flows from reservoirs (friction losses in pipelines/penstocks, for example), and those which occur inside the turbines, generators, transformers and transmission systems.

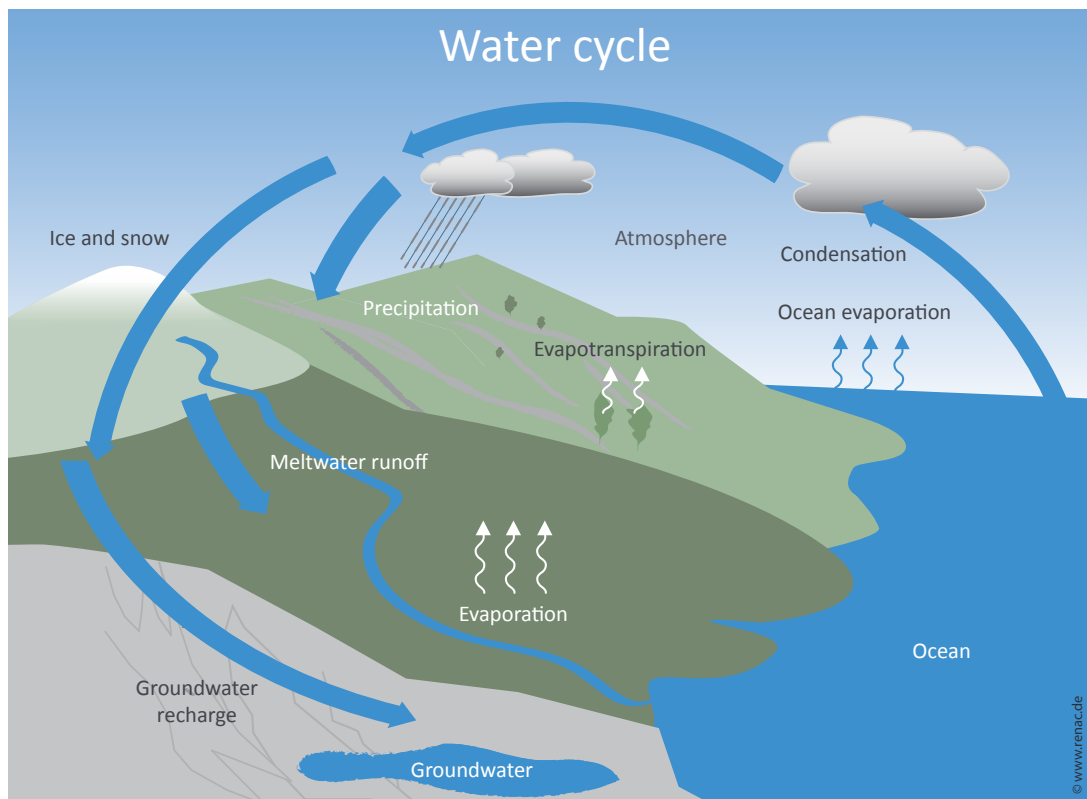


Figure 3.1.8.1: The water cycle (also called the hydrological cycle). | Graphic: RENAC.

The energy contained in a volume of water is described by the following formula:

$$E = \rho \times g \times h \times V$$

where

$E$  is energy [J]

$\rho$  is the density of water [kg/m<sup>3</sup>]

$g$  is acceleration due to gravity [9.81 m/s<sup>2</sup>]

$h$  is the hydrostatic head (the height difference between where water enters the system and the turbine) [m]

$V$  is volume of the water [m<sup>3</sup>]

The power that can be generated by a hydroelectric power plant is described by the following formula:

$$P = \rho \times g \times h \times Q \times \eta$$

where

$P$  is power generated [W]

$\rho$  is the density of water [kg/m<sup>3</sup>]

$g$  is acceleration due to gravity [9.81 m/s<sup>2</sup>]

$h$  is the hydrostatic head (height the water falls) [m]

$Q$  is the flow [m<sup>3</sup>/s]

The average efficiency of hydroelectric power plants ranges between 65% and 90%, depending on the age and type of plant. With new or modernised plants, an overall efficiency of 85 to 90% can be achieved.

### Types of hydroelectric power plants

Besides using dams, hydroelectric power plants can also avoid storage, by being 'run-of-river' power plants. These use the energy of the watercourse (inflow) directly by either installing turbines in rivers, or diverting a proportion of the water flow into a channel/pipeline to power turbines before returning it to the river further downstream. These are sometimes called river diversion hydroelectric plants.

Dam-fed hydroelectric power plants can be classified according to their capacity, the size of the water storage facility, and the different storage regimes (daily storage, weekly storage, seasonal or annual storage). In some plant designs, water from other watercourses can also be fed to the turbines via channels.

River diversion hydroelectric plants are typically found on meanders or in other river sections. Depending on the design of the dam and the 'waterway system' (the hydraulic system in which the water that powers the turbines flows), it is also possible for river

Turbine type	Hydroelectric application	Flow rate/ flow volume
Kaplan turbine	Low pressure	High flow rates
Francis turbine*	Medium to high pressure	Medium flow rates
Pelton turbine	High pressure	Low flow rates
Screw turbine	Low pressure	Low flow rates

Table 3.1.8.1: Types of turbines used in hydroelectric plants. | \* Also used as a pump (reverse operation) in pumped-storage hydro systems.

diversion hydroelectric plants to have water storage systems (reservoirs, storage tunnels). Hydroelectric power plants can be further classified according to their head height and their water pressure and flow rates, as follows: low pressure power plants (head of up to 25 m), medium-pressure power plants (head of approx. 25 m to approx. 250 m) and high-pressure (head greater than 250 m). Hydroelectric power plants with reservoirs often serve several functions. In addition to producing electricity (the main function), plants can also be used for flood protection, be a component of a water supply system, or a component of an irrigation system, and reservoirs can be used for tourism and recreational purposes. Waterways and canals are also often built in connection with hydroelectric power plants. These days, several consecutive power plants can be found on larger rivers. These are referred to as ‘cascade’ systems. The operation of the individual hydroelectric plants is coordinated with the others; each power plant uses the same amount of water, but each operates in time-delayed succession.

### Other types of hydroelectric plants

Pumped-storage hydroelectric plants are a special type of hydroelectric power plant – some of which have reservoirs which are also fed by rivers. They help to integrate intermittent renewable energy power sources, such as wind and solar power, into electric power grids, because they can store and/or buffer electrical energy and help stabilise the operation of the grid. Another type of hydropower plant is marine power plants, which harness the kinetic energy of ocean currents, tides, or waves. These are used in coastal areas, estuaries (marine current and tidal power plants) or in the open sea (marine current and wave power plants).

## Main components of hydroelectric power plants

Hydroelectric plants consist of the following main components:

- the storage facility (dam, reservoir, water catchment area), water inlet structure (including mechanical cleaning to remove debris/sand), water shut-off mechanisms, the waterway system (tunnels, channels, pipelines)
- the powerhouse, which contains the electromechanical and electrical equipment (turbines, generators, transformers, control technology)
- other auxiliary and ancillary facilities, the underwater side waterway (including possibly surge compensation tank), outlet structures for returning the water into watercourses.

The powerhouse can be above or below ground. Furthermore, each hydroelectric plant connected to the grid will have a transformer substation, connected via underground or overhead power lines. A variety of turbine types and turbine-generator constellations have been developed, each appropriate for different power plant requirements and local conditions (watercourse type/terrain).



Figure 3.1.8.2: Reservoir with intakes of a hydroelectric power plant. | Source: Fotolia.

## Use of hydroelectric power plants

Hydroelectric power plants can be used for either the continuous, regular or short-term production of electricity, depending on the availability of water (permanent or seasonal) in the water catchment area or storage facility, and on the available hydrostatic head. Furthermore, hydroelectric plants can provide ancillary services to the grid, such as grid frequency maintenance, grid voltage maintenance, baseload provision or network regulation / grid stabilisation, and repowering the grid in the event of grid power outage (black start, island operation). Run-of-river hydroelectric plants are mainly used for baseload and intermediate load provision. Hydroelectric storage plants and pumped-storage power plants can produce electricity at short notice and are therefore mainly used to cover short-term power needs; additionally, pumped-storage hydroelectric plants can consume excess electricity at short notice and store it. Because pumped-storage hydroelectric power plants have the great advantage of being able to effectively store electricity as potential energy, they are used to provide ancillary services to the grid and provide black-start capability.

## Role of hydroelectric power globally

Hydroelectric power is currently the most widely-used renewable energy source. At the end of 2016, hydroelectric power accounted for around 4,100 TWh (approximately 17%) of global power generation. Most of the world's hydroelectric plant capacity is installed in China, Brazil, USA, Canada, Russia, India and Norway – this corresponds to approximately 63% of global output. The largest increases in installed capacity in recent years have occurred in China, Brazil, Turkey, India, Vietnam and Malaysia.

## Global hydroelectric potential

Hydroelectric power will continue to play an important role in global electricity supply in the future. Significant potential for expanding power plant capacities still exists in many countries around the world. The growth rate for hydroelectric power averaged 3.3% per year between 2004 and 2014. The upward trend in electricity generation from hydropower is expected to continue into the future. According to forecasts and scenarios from various energy institutes, the current level of global electricity generation from hydropower will increase by one to two-thirds by 2040 (not including marine power plants).

## Hydropower in Germany

Germany has about 7,400 hydroelectric power plants, with a total installed capacity of around 4 GW (11.2 GW including pumped-storage hydro plants). Total energy production from these plants is about 17 TWh (including 21.5 TWh from pumped-storage plants with reservoirs fed by rivers – counting only the contribution from river flow), of which about 60% comes from plants in Bavaria and 20% comes from plants in Baden-Württemberg. This amounts to approximately 3.2% of gross electricity generation in Germany.

Under the right framework conditions, electricity production from hydropower in Germany could be increased to approximately 30 TWh (including pumped-storage) by 2030. One third of this could be achieved by plant modernisation measures, another third by reactivating formerly abandoned plants, and a final third by the construction of new plants. Because of the age of many of the plants in current operation (up to one hundred years), the potential for modernisation of existing plants is considerable. A modernised plant can provide up to one-third more performance; but an additional extraction licence is required because modernisation usually involves increasing the amount of water extracted from the watercourse [29] – [36].

### 3.1.9 Hybrid systems

#### 3.1.9.1 Definitions, characteristics, examples

*Andreas Wiese, Paul Freunsch*

Hybrid power systems are plants that produce electrical energy using one or more energy sources, and in which the energy production and/or energy storage is based on one or more different technologies which are combined to form an integrated overall system that is operated at one location.. Hybrid power systems involve either at least two energy sources or at least two different energy conversion or energy storage technologies. By this definition, combinations of power generation technologies which utilise the same energy resource (such as PV and CSP) but with a single storage technology at a single location also count as hybrid power systems or plants. As a general rule, the operation of such systems is managed by an integrated control system.

Hybrid systems usually involve the use of renewable energy sources and very often they are smaller decentralised systems which supply individual consumers, or small electric power grids in remote regions.

## Implications for renewable energy

In traditional power plants, the energy is stored in fossil fuels and can be converted into electricity at any time. However, in the case of wind and solar power, electrical energy is not available at any time unless there is some form of energy storage. As a result, power plants that convert wind and/or solar radiation directly into electric energy and feed this electricity immediately into the grid or to the customer, are not able to provide, on their own, a reliable, round-the-clock supply. Therefore other technologies must also be used – either other power plants or energy storage technologies. Combining electricity generation from wind and solar with each other or with other renewable energy technologies such as biogas or micro-hydro can in addition reduce the need for energy storage or conventional power plant technology.

## Advantages and challenges

Hybrid power systems offer the following benefits:

- Demand-driven power generation: hybrid systems offer the possibility of matching the generation of electricity at the power plant site directly with electricity demand (generating electricity at the times when it is required) – the electricity is usually consumed in the vicinity of the system or plant. As a result, appropriately designed hybrid systems are not necessarily dependent on larger electric grid networks and the combined power generation capacity of other power plants.
- By combining solar or wind power plants with energy storage technology, hybrid systems can enable any desired share of renewable energy up to a supply entirely with renewable energy at a single location.
- Possibility of shared infrastructure: when power generation is supplied by different technologies at one location, some of the necessary infrastructure can potentially be shared; this leads to cost savings and reduced land-area requirements.

With a combination of different renewable energy technologies in a single system, there may be other added benefits at certain locations. For example, at locations where wind speeds are high in winter and solar irradiation is high in summer, the use of both wind and solar technology can result in either a more even and more reliable power supply, or, ideally, a closer match of the combined wind and solar power generation to the electricity demand profile. In this kind of situation, the need for the remaining demand to be

covered by energy storage or diesel generators may be reduced, to cover periods of low wind speeds and low solar irradiation.

However, there are some challenges that need to be considered when planning, installing and operating hybrid power systems:

- Individual solutions are required: there is no generally applicable solution for the design of hybrid power plants; the design of the system must always be planned and designed to match local conditions.
- Complexity: the combination of different energy generation technologies results in greater complexity – in the design, construction and operation of systems. For this and other reasons, training needs for operating such systems are greater (see Chapter 3.1.9.2 Hybrid systems – design aspects).
- Cooperation across field of expertise is required: in order to successfully design, construct and operate hybrid power plants, experts and companies from a range of power-generation and energy storage technology sectors need to work together on an interdisciplinary basis.

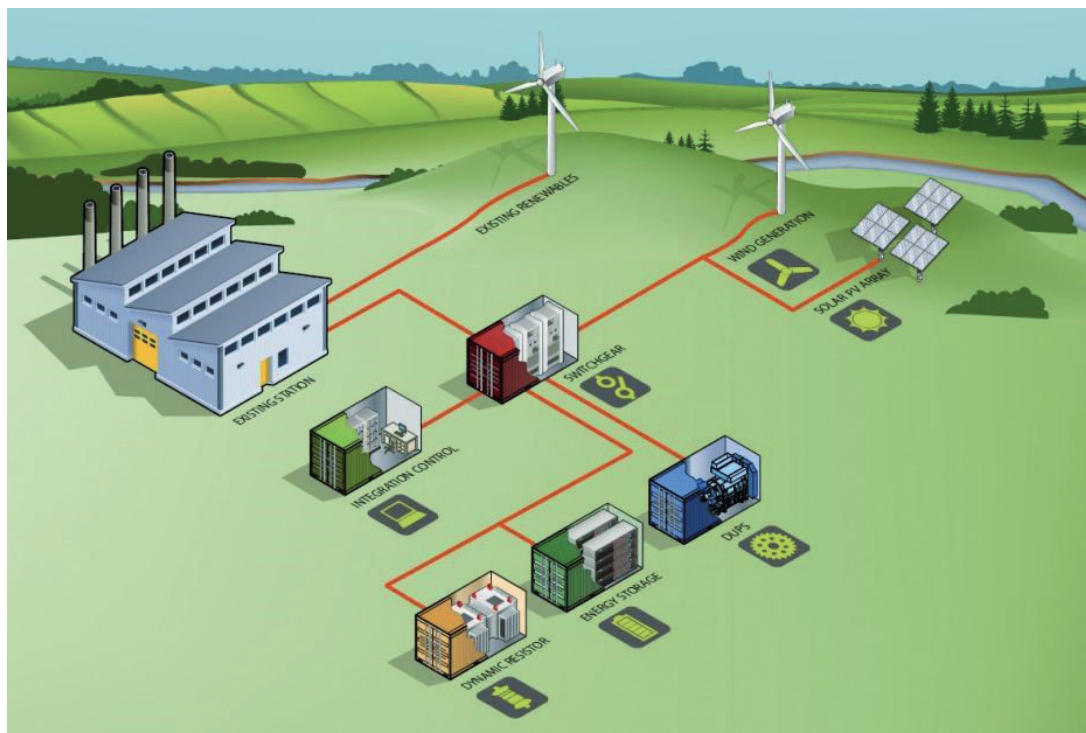


Figure 3.1.9.1.1: Schematic of a decentralised (not connected to a national power grid) wind and solar hybrid electrical system. | Source: Hydro Tasmania, Australia.



## Typical examples of hybrid systems

### *Decentralised wind and/or solar electric hybrid systems*

Decentralised hybrid systems are hybrid systems which (usually) operate independently from a national power grid and/or may not be connected to a national power grid (sometimes called 'off-grid'). In these systems, various renewable energy technologies are combined with energy storage technologies and/or diesel power plants (see Figure 3.1.9.1.1). In the simplest systems, only a PV system with a battery bank or a PV system with a diesel generator are used. In principle, other renewable energy technologies are also feasible in decentralised systems, such as small hydropower or biomass. Most current decentralised systems include solar and/or wind power. These types of decentralised systems usually deliver power in ranges of a few hundred kilowatts to a few megawatts. The choice of renewable energy generation technology depends largely on which renewable energy resource can be utilised at the site at the most favourable cost, and on what regulatory requirements need to be complied with (for example, environmental protection requirements).

### *Solar thermal electricity generation with thermal energy storage*

In this type of systems, solar thermal power plants – (electricity generating concentrated solar power (CSP) plants – are used in combination with solar thermal energy storage. Energy storage enables power to be produced not only when the sun is shining but also at night and during periods of low sunshine. The main system components are solar collectors (e.g. parabolic dishes, or heliostat mirrors plus a solar tower), a turbine, and a molten salt energy storage facility. System sizes start at 50 MW (see Chapter 3.1.9.2 Hybrid systems – design aspects).

### *Solar thermal power generation combined with photovoltaics (PV)*

These types of hybrid power plants have rated capacities of 100 MW or more and feed electricity into a larger electric power grid. The aim is to enable the infrastructure at the site to be shared by both the CSP plant and the PV plant, in order to lower costs, and to optimise the harnessing of solar energy at a single site. By combining PV, which feeds power directly to the grid during the day, and CSP, in combination with thermal energy storage which can provide electricity after dark, it is expected that more cost-effective generation of electricity can be supplied than by either a PV plant or a CSP plant on its own. This type of combination is currently being implemented only at a few locations; however, it has become an interesting option, especially due to the recent considerable

cost reduction of photovoltaics. The largest plant of this type is currently being planned and built in Midelt, Morocco.

#### *Solar thermal power generation combined with gas and steam turbines*

This type of system has a combined cycle power plant, with some of the energy required to drive the turbine provided by solar thermal collectors. The technology is known as ISCCS (integrated solar combined cycle system).

Up to about 20% of gas can be saved fuel can be saved in these systems. A higher proportion of electricity can be generated by renewable energy if solar thermal energy storage is also included. For this type of system, in addition to a combined cycle power plant, sufficient open land area, a high level of direct solar radiation, and appropriate topography are required. If these conditions can be met, this type of hybrid system can be attractive because of the possibility of sharing infrastructure and increased independence from fossil-fuel prices. To date, power plants of this type exist mainly in North Africa, the Middle East and the USA.

### **3.1.9.2 Hybrid systems – design aspects**

*Francois Botreau, Alex Loosen*

Hybrid systems are defined as those with a combination of different energy generation and/or storage technologies which utilise the advantages of each technology to maintain stable energy supply/production for a specific load(s). Against the backdrop of a significant drop in cost of renewable energy technologies and other energy-supply associated challenges, hybrid solutions are becoming a part of electrical supply systems globally. Because hybrid systems combine different power system technologies using various renewable resources (for example, solar, wind, biomass), they are technically complex.

Renewable energy equipment and storage systems are undergoing rapid development. This is leading to an ongoing evolution of technological design options and specific investment costs which need to be considered when optimising the design and layout of effective, reliable, and economically viable systems with low levelised energy costs over the project lifetime. Financing institutions are showing an increased interest in hybrid system projects, as are operators of small power grids working in remote areas where electricity costs are high due to high fossil fuel and operating costs.

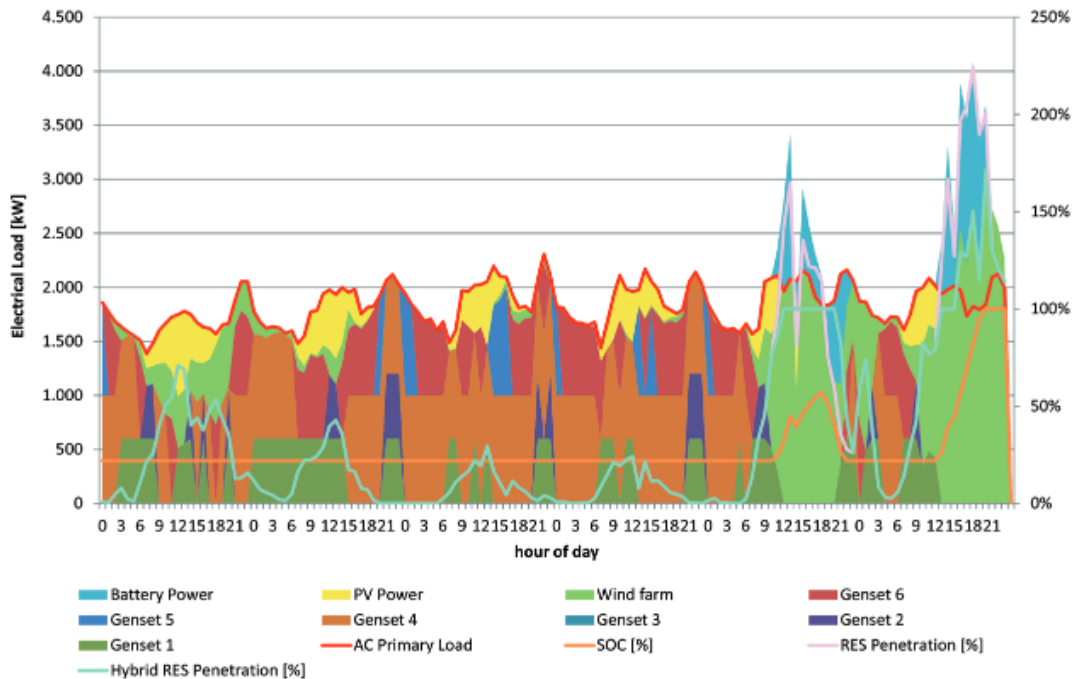


Figure 3.1.9.2.1: Example of hourly simulation results of a hybrid system composed of wind turbines, PV, batteries and diesel gensets. | Source: Lahmeyer.

Up until recently, large centralised generation of electricity has been the norm, while small, sometimes hybridised, decentralised solutions filled the gaps for remote areas where centralised generation is not possible from an economic perspective, and where grid extension would be costly. As smart grid solutions and intermittent renewables are rolled out on a large scale, this separation between centralised generation and decentralised hybrid solutions will become less clear, and the demand for hybrid solutions and associated intelligent control systems will increase.

### Power generation systems

Photovoltaic (PV) systems utilise semiconductor materials for the direct conversion of solar energy (photons) into electricity. Power generation is directly related to the intensity of solar radiation, and follows a diurnal pattern. Wind turbines use an aerodynamic effect to capture energy from moving air and convert this into mechanical form, and, using a generator, into electrical energy. Generation is difficult to predict in the short term, and can have seasonal variation. Internal combustion engines burn a volatile fuel and convert the released energy into mechanical energy, and, using a generator, into electrical energy. Fuel sources can be fossil (e.g. diesel, HFO, natural gas) or biofuel (e.g. bioethanol, bio-diesel). Generation is stable and predictable if fuel supply is secured.

## Energy storage systems

Energy storage systems in hybrid systems can fulfil several functions, such as:

- Regulating power quality (frequency/voltage/reactive power)
- Compensating for the intermittency of renewable energy sources in order to achieve a higher use of renewable energy, and
- Enabling 'load shifting' to achieve a better match between a renewable energy resource and load demand.

Various energy storage technologies are suited to different applications. These include batteries, pumped hydro, compressed air, super-capacitors, hydrogen-based solutions, and flywheels.

Batteries are the most commonly used storage system in hybrid systems. Batteries utilise chemical energy storage to store electrical energy. The most common battery types are lead-acid, Ni-Cd, and Li-ion. Energy storage periods are typically a few hours to a few days, depending on the system design and function. Li-ion battery technology currently shows high promise regarding future development. With increased progress in battery research and battery applications (particularly in the automotive industry) and subsequent cost decreases, it is expected that batteries will play a larger role globally in electricity supply systems over the coming years.

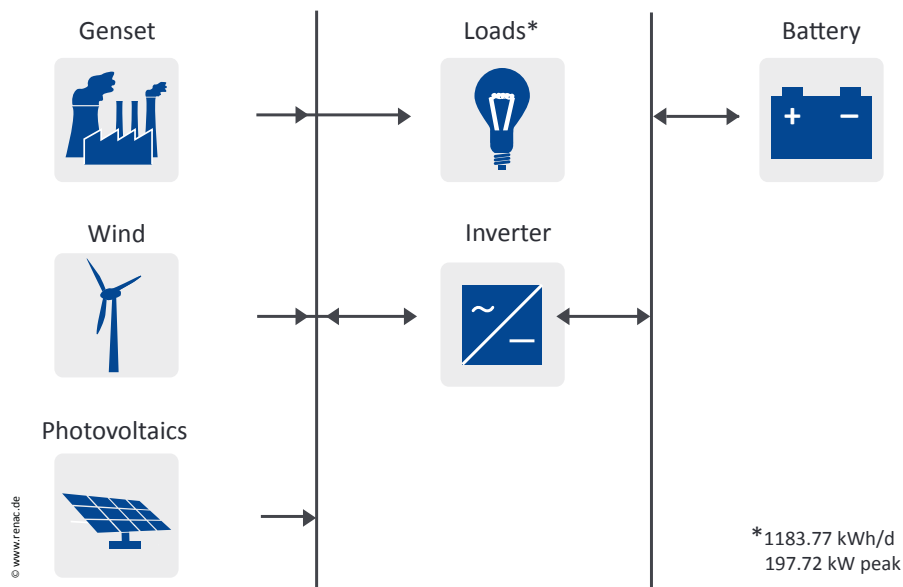


Figure 3.1.9.2.2: Example of the schematic modelling of a hybrid system. | Graphic: RENAC.

Hybrid systems are designed specifically for each application. The aim is to provide an energy supply which is as reliable as possible. Stability of supply is achieved via generation control, and voltage and frequency control. The power generation potential of the renewable energy resource (such as wind or solar) must be studied in detail for the specific site. In addition, security of supply of any fossil fuel or biofuel to be used in the system must be assured. Active power generated must, at all times, equal the active power consumed in order to control system frequency. Reactive power must be provided when necessary in order to maintain system voltage. Both these controls are necessary to maintain system operability.

In systems which have intermittent power production sources such as solar and wind, the operating reserve must be properly configured and designed to be able to deal with expected power supply fluctuations within short periods of time. Due to the use of intermittent renewable energy sources and high technical requirements to ensure grid stability, controller design and operational limits must be carefully analysed at the design stage. A key challenge when designing hybrid systems is assessing the electrical demand to be met by the system. Hourly load profiles and data on seasonal load variations are highly important when selecting the most suitable technologies to use in the hybrid system. Load profile assessments are carried out on a project-by-project basis and the methodology must be appropriate for the targeted application (for example, hybridisation of existing diesel genset systems, rural electrification of previously non-electrified areas, etc.). Possible deferrable loads should be identified and demand side management possibilities should be considered whenever possible.

To ensure the longevity of hybrid systems, realistic assumptions regarding future electricity demand growth must be taken into consideration, as well as modularity in design to allow for future upgrades. Due to the complexity of hybrid systems, reliable modelling tools are necessary to simulate the production of the various sources of power generation and meet the required electrical demand on an hourly basis over the year.

Training of local operation and maintenance personnel is important for decentralised hybrid systems, as several technologies are involved. This is key to ensuring project longevity. In rural electrification projects, it is important that communities establish a suitable payment structure for the electricity produced and consumed. Paying for the electricity increases the sense of responsibility among the system users, and leads to community involvement and more effort to keep the system in operation over the long term. Historically, the focus for hybrid solutions has been islands and remote villages which cannot easily avail of centralised power generation. This niche market will

continue to exist; however, hybrid technology solutions will begin to carry over to larger power grids as renewable generation becomes cheaper and more ubiquitous.

One is beginning to see hybrid systems in homes and other buildings in industrially-developed countries with robust power grids. This is a result of a significant decrease in renewable and hybrid system costs and the increased reliability of these systems. Areas of research and development include the utilisation of electric-vehicle batteries, home hydrogen storage systems, small-scale PV, and wind power (all on a residential level), plus the emergence of smart grids.

### **3.1.10 Combined heat and power (CHP) plants**

*Arno Stomberg*

When electricity is generated by via a combustion process (e.g. by burning fossil fuel), heat is also generated. A combined heat and power (CHP) plant is a power plant that also enables this heat to be used. CHP is regarded as an important, and for many, the most important pillar of the Germany government's future energy policy. CHP plants enable the most efficient use of both fossil and renewable fuels. The CHP share of net electricity generation in Germany in 2016 was around 19%. [19]

#### **Different types of CHP plants**

There is no one type of CHP plant. The type of gas engine system that is used with biogas is only one of several types of CHP generator. CHP generators/plants can be roughly categorised according to four different criteria:

##### 1. Fuel used

- Solid fuel (coal, wood, etc.)
- Liquid fuel (vegetable oil, etc.)
- Gas fuel (biogas, natural gas, hydrogen, etc.)

##### 2. Fuel combustion method

- Solid fuel gasifier
- Oven-type solid fuel burners
- Gas turbines
- Engines powered by liquid and gaseous fuels

### 3. Heat generation method

- Steam boilers
- Thermal oil boilers
- Hot water systems

### 4. Electricity generation method

- Steam turbine generators
- Gas turbines generators

In principle, any combination of the four technologies described above can be combined to construct a CHP plant. Plants can be designed for all power ranges from 1 kW upwards, and can be easily integrated into decentralised power supply systems.

### **What are the advantages of CHP plants?**

The generation of both electricity and useful heat results in very high fuel utilisation rates, of more than 90%. Additionally, in some cases, the gross calorific value ('higher heating value') of the fuel used can be utilised, so that even higher efficiencies are possible. This makes it possible to achieve a very positive environmental balance with regard to CO<sub>2</sub> emissions. And if a renewable fuel is used, CHP is almost carbon neutral.

In addition to a positive environmental balance with regard to CO<sub>2</sub> emissions, the high energy efficiency of CHP plants is also an economic advantage. In Germany, the use of CHP plants is promoted – via measures specified in the Combined Heat and Power Act (KWKG 2017) – with additional payments for electricity generated, which is a further incentive to use this technology. The 2017 amendment to the German Renewable Energy Sources Act (EEG) moved from providing a fixed feed-in tariff for CHP-generated electricity to competitive tendering procedures. In addition to the climate-protection and economic-efficiency aspects of CHP plants, their operational flexibility (ability to be ramped up and ramped down in response to electricity demand and supply from other energy sources) when they are used in a network that also has intermittent renewable energy powered generators, is also important. By extending the funding framework until 2022 and specifying the expansion target, the German government has provided more planning certainty to CHP plant operators.

### **Design considerations for CHP plants**

To be economically viable, the sizing of a CHP plant needs to be based on the demand for the energy it will produce. This will usually be geared to the continuous load requirement for the heat or electricity demand of the consumer(s); partial load operation of a plant would reduce plant efficiency. This means that a very good knowledge demand

profile of the consumer(s) is mandatory. This is the basis for a CHP plant that ‘pays’, from both the economic and environmental point of view. Designing a ‘customised’ plant, which takes all factors into account, is a complex engineering task. A properly designed and highly efficient CHP plant should operate economically most of the time; and, especially when renewable fuels are used, contribute to the reduction of CO<sub>2</sub> emissions [38].

## References

- /1/ Hans-Martin Henning, Andreas Palzer 2013. Energiesystem Deutschland 2050, Fraunhofer-Institut für Solare Energiesysteme ISE, Freiburg/Breisgau, Germany, 2013.
- /2/ BMWi 2018: Zeitreihen zur Entwicklung der erneuerbaren Energien in Deutschland.
- /3/ Kaltschmitt, M.; Streicher, W.; Wiese, A., 2013, *Erneuerbare Energien*, Springer Verlag, ISBN 978-3-642-03248-6.
- /4/ Weiss, W., Spörk-Dür, M., Mauthner, F. 2016. *Solar Heat Worldwide, Global Market Development and Trends in 2016, detailed Market Figures 2015*. IEA Solar Heating & Cooling Programme. IEA, Paris (2017) – <http://www.iea-shc.org/solar-heat-worldwide-past>.
- /5/ Bundesverband Solarwirtschaft e.V., 2017, Statistische Zahlen der deutschen Solarwärmebranche (Solarthermie) für Ende 2016.
- /6/ Deutsche Solarthermie Technologieplattform, 2016, DSTTP Solarthermiestrategie 2020+.
- /7/ <http://solar-district-heating.eu/ServicesTools/Plantdatabase.aspx>, abgerufen am 10.12.2017.
- /8/ Fraunhofer ISE (2018): Photovoltaic Report 2017/18.
- /9/ [www.unendlich-viel-energie.de/erneuerbare-energie/bioenergie](http://www.unendlich-viel-energie.de/erneuerbare-energie/bioenergie).
- /10/ [www.umweltbundesamt.de/themen/klima-energie/erneuerbare-energien/erneuerbare-energien-in-zahlen#statusquo](http://www.umweltbundesamt.de/themen/klima-energie/erneuerbare-energien/erneuerbare-energien-in-zahlen#statusquo).
- /11/ [www.unendlich-viel-energie.de/veroeffentlichungen/potenzialatlas-bioenergie-2020](http://www.unendlich-viel-energie.de/veroeffentlichungen/potenzialatlas-bioenergie-2020)
- /12/ [www.fnr.de/fileadmin/allgemein/pdf/broschueren/broschuere\\_basisdaten\\_bioenergie\\_2017\\_2.pdf](http://www.fnr.de/fileadmin/allgemein/pdf/broschueren/broschuere_basisdaten_bioenergie_2017_2.pdf), S. 10-11
- /13/ <https://biogas.fnr.de/gewinnung/gaersubstrate/>, Stromerzeugung aus Biomasse, DBFZ (2015)
- /14/ [www.wind-energie.de/presse/meldungen/2017/bwe-stellungnahme-zu-gemeinsamen-ausschreibungen-wind-und-pv-gemav](http://www.wind-energie.de/presse/meldungen/2017/bwe-stellungnahme-zu-gemeinsamen-ausschreibungen-wind-und-pv-gemav), Stellungnahme, Seite 1.
- /15/ [www.erneuerbare-energien.de/EE/Navigation/DE/Recht-Politik/EEG-Ausschreibungen/Windenergie-auf-See/windenergie-auf-see.html](http://www.erneuerbare-energien.de/EE/Navigation/DE/Recht-Politik/EEG-Ausschreibungen/Windenergie-auf-See/windenergie-auf-see.html)
- /16/ [www.umweltbundesamt.de/daten/klima/klimaschutzziele-deutschlands#textpart-2](http://www.umweltbundesamt.de/daten/klima/klimaschutzziele-deutschlands#textpart-2)
- /17/ Umweltbundesamt, Emissionsbilanz erneuerbarer Energieträger unter Verwendung von Daten der AGEE-Stat, Stand 12/2017.
- /18/ [www.swm.de/erneuerbare-energien/energiequellen/wind.html](http://www.swm.de/erneuerbare-energien/energiequellen/wind.html)
- /19/ DGGV/DGGT study group (2014): Sass, I., Brehm, D., Coldewey, W. G., Dietrich, J., Klein, R., Kellner, T., Kirschbaum, B., Lehr, C., Marek, A., Mielke, P., Müller, L., Panteleit, B., Pohl, S., Porada, J., Schiessl, S., Wedewardt M., Wesche D.: *Shallow Geothermal Systems – Recommendations on Design, Construction, Operation and Monitoring*, 2016.



- /20/ Bauer, D., Drück, H., Heidemann, W., Marx, R., Nußbicker-Lux, J., Ochs, F. (2013): Solarthermie2000plus: Wissenschaftlich-technische Begleitung des Förderprogramms Solarthermie2000plus zu solar unterstützter Nahwärme und Langzeit-Wärmespeicherung. Forschungsbericht zum BMU-Vorhaben FKZ 0329607P (Aug. 2008 bis Sep. 2012) Institut für Thermodynamik und Wärmetechnik (ITW), Universität Stuttgart.
- /21/ UBA – Umweltbundesamt (*German Environment Agency*) (2015): Auswirkungen thermischer Veränderungen infolge der Nutzung oberflächennaher Geothermie auf die Beschaffenheit des Grundwassers und seiner Lebensgemeinschaften – Empfehlungen für eine umweltverträgliche Nutzung. Texte 54/2015.
- /22/ VBI, *Shallow Geothermal Energy – VBI Guidelines for Projects in Germany*, <https://www.vbi.de/shop/shallow-geothermal-energy-vbi-guidelines-for-projects-in-germany/>.
- /23/ Sass, I.; Heldmann, C.-D. & Schäffer, R. (2016): Erkundung und Beweissicherung für eine geothermale Erschließung eines Alpenin Karstaquifers im Tuxertal, Österreich.-Grundwasser 10.1007/s00767-015-0312-x.
- /24/ Steiner, S.; Lemeš, Z.; Sass, I.; Welsch, B.; Rühaak, W. & Bär, K. (2014): Mitteltiefe Erdwärmesonde Heubach – Erfahrungen und Schlussfolgerungen.- Proc. Deutscher Geothermiekongress, Essen.
- /25/ Bär, K.; Homuth, S.; Rühaak, W.; Schulte, D.; Welsch, B. & Sass, I. (2015): Coupled Renewable Energy Systems for Seasonal High Temperature Heat Storage via Medium Deep Borehole Heat Exchangers.-Proc. World Geothermal Congress, Melbourne.
- /26/ Welsch, B., Bär, K., Schulte, D., Rühaak, W., Chauhan, S., Sass, I. (2015): Simulation und Evaluierung von Kopplungs- und Speicherkonzepten regenerativer Energieformen zur Heizwärmeversorgung. Forschungsbericht zum HessenAgentur Projekt Nr. 375/13-14, Technische Universität Darmstadt.
- /27/ Paschen, H., Oertel, D. & Grünwald, R. (2003): Möglichkeiten geothermischer Stromerzeugung in Deutschland. Büro für Technologiefolgen-Abschätzung beim deutschen Bundestag.–Deutscher Bundestag, Ausschuss für Bildung, Forschung und Technikfolgenabschätzung, 128. S.
- /28/ [www.geotis.de](http://www.geotis.de)
- /29/ Bundesverband Deutscher Wasserkraftanlagen, <http://www.wasserkraft-deutschland.de/>; Abruf Homepage 21.11.2017.
- /30/ dena (Deutsche energie Agentur), homepage (30.01.2017).
- /31/ *Die Rolle von Pumpspeicherwerken zur Integration erneuerbarer Energien im Kontext des Neubauprojektes PSW Atdorf*, dena 2005.
- /32/ <http://www.et-energie-online.de/AktuellesHeft/Topthema/tabid/70/NewsId/1518/Bedeutung-der-Wasserkraft-fur-die-weltweite-Stromerzeugung.aspx>, 21.11.2017/
- /33/ <http://www.ren21.net/status-of-renewables/global-status-report/>, Renewables 2016; Global Status Report
- /34/ Hydropower Status Report 2017, IHA.
- /35/ Von der Kraft des Wassers, Georg Küffner, DVA München 2006.
- /36/ Vorbereitung und Begleitung der Erstellung des Erfahrungsberichts 2014 gemäß § 65 EEG im Auftrag des Bundesministeriums für Wirtschaft und Energie; März 2015.
- /37/ *Wasserkraftanlagen*, Giesecke/Mosonyi, Springer-Verlag 2009.
- /38/ <https://de.statista.com/statistik/daten/studie/307108/umfrage/anteil-der-kwk-stromerzeugung-an-der-gesamtstromerzeugung-in-deutschland/>.
- /39/ [www.umweltbundesamt.de/daten/energiebereitstellung-verbrauch/kraft-waerme-kopplung-kwk#textpart-5](http://www.umweltbundesamt.de/daten/energiebereitstellung-verbrauch/kraft-waerme-kopplung-kwk#textpart-5)

## 3.2 Power transmission, distribution and management

### 3.2.1 The challenge of renewables – the German power grid

*Dirk Schramm*

About 38% of electricity was generated by renewables in Germany in 2017 (provisional figure from November 2018). This is extremely good for a leading industrial economy, but it also presents enormous challenges for all concerned. The renewable energy auction schemes that are used to support the further expansion of renewables, in particular large-scale wind and PV plant projects, are bringing changes. Industry observers expect a decline in the number of new installations in the future because of grid limitations. However, these auction rounds have ensured that projected specific generation costs per kW have dropped significantly – they are currently at 4.33 euro cents per kWh for PV projects and 4.73 euro cents per kWh for wind projects [1]. These price drops were also made possible by economies of scale, and by reductions in the specific costs of plants.

The decision to phase out nuclear power by 2022 is likely to have a significant impact in the years immediately following this. Nuclear power plants, many of which are located in southern Germany, will go offline. This will increase the need for grid expansion in order to make up the resulting power shortfall in southern Germany with power from northern Germany, where new wind power capacity is being installed, both onshore and offshore. New transmission lines will be required. The current German high-voltage transmission grid, with its 380 kV and 220 kV networks, is not yet sufficient to transmit this power from northern Germany. Additional HVDC (high voltage direct current) lines are being planned. The HVDC line SuedOstLink will transmit power 500 km from Wolmirstedt in Saxony-Anhalt to the Isar river in Landshut (Bavaria). The HVDC line SuedLink will stretch 560 km from Wilster in Schleswig-Holstein to Grafenrheinfeld in Bavaria.

Overhead HVDC lines were initially planned, but it was announced after an energy summit on 2 July 2015 that underground lines are to be the preferred option in order to achieve a higher level of public acceptance. Only the SuedLink is expected to incur additional costs – of approximately €8 billion – because of this change. Under the current (end of 2018) Electricity Grid User Charge Ordinance (German: *Stromnetzentgeltverordnung* or *StromNEV*), this will ultimately result in additional costs for grid customers of approximately €600 million per year over the 40-odd years standard operational life of the line.

Despite these additional costs being approved, the successful implementation of these projects is still pending. The participating grid operator Tennet originally expected

construction of the SuedLink to start in 2016, with completion due in 2022. However, at the end of 2018 construction work was not yet reported to have begun, with the underground line being very controversial among certain sections of the public – especially those living along the proposed line routes. Whether the line will be completed remains uncertain at the present time.

The grid upgrade and expansion measures required for the regional 110 kV transmission grids are also significant. Ensuring grid control and stability also places high demands on the management of the 110 kV grids, and on the subordinate medium-voltage grids. The operators of grids in urban conglomerations, but also of the rural medium-voltage grids, will also be impacted by the addition of renewable energy generation plants to the network. Expansion and further development of these grids are also needed. There are small municipality grids in Bavaria that take approximately  $P_{\max} = 2,000$  kW from the higher-level grid in the winter half of the year; but also feed power into the higher-level grid from renewables, especially from PV systems of approximately  $P_{\max} > 6,000$  kW. In order to facilitate this two-way transmission between the upper and lower levels of the grid, further upgrades are necessary.

In medium-sized municipal utilities with, for example, 10,000 grid customers, up to 1,000 decentralised renewable energy feed-in systems are not only common, but are increasingly the rule. In these compact grid networks, there is a significant reduction of power demand from the upstream grid in peak-load periods. Electricity generated from renewable energy systems is consumed (physically) by customers in the immediate vicinity of its generation. Appropriate proposals for further upgrades of these grids are urgently needed. At the time of writing, grid operators in Germany are in the last year of the so-called second ‘incentive regulation period’ set out by the Incentive Regulation Ordinance (German; *Anreizregulierung* or *ARegV*). From 2019, an amendment to this ordinance will take effect during the third ‘incentive regulation period’ (2019 – 2023). Starting in 2019, the delay previously experienced between the year in which capital expenditure is made on necessary investments in the grid infrastructure and the year in which it is permitted to deduct them from revenue calculations will disappear. The capital costs of new investments will be factored into the calculation of the revenue cap in the same year as they are made; this would typically result in an increase on the cap, to the benefit of operators. Welcomed though this will be by grid operators, this stimulus for future investments will still require rigorous financial planning [2].

The challenges of renewable energy continue to be exciting. Ultimately, there is no alternative to the transition towards a renewables-based energy supply system; but how that is to be cost-effectively achieved remains a topic for exploration.

### 3.2.1.1 Grid integration of renewable energy

*Harald Schwarz*

Unfortunately, when the transition from fossil fuels towards renewable energy is being considered, the focus is often placed exclusively on energy quantity; the quantity of energy generated in a year from renewable sources is added up and compared with annual energy requirements. However, this simple approach only works if the energy generated from renewables can be stored in some way, via some relatively non-complex means, on a large scale, and close to where the energy is produced. With biomass and, to a certain extent, with biogas, this can be done relatively straightforwardly.

It is much more difficult for energy sources/carriers that need to be distributed via networks such as electric power grids and gas pipelines – such as hot water, steam, gas, but above all electricity. Electric power grids have been developed over many decades under the premise that feeding energy into the grid can always be planned and controlled. Electricity demand on the power grid was the main control factor determining the amount of energy fed into the grid, and energy storage facilities were only used to the extent that they were necessary for an energy- and cost-optimised overall operation of the overall system. The increasing use of renewable energy sources and technologies requires adjustments to this system.

In Germany over the past 20 years, since the Renewable Energy Sources Act or EEG (German: *Erneuerbare-Energien-Gesetz*) was enacted, the vast majority of energy generated from renewables has been electricity, and this has been fed into the low-, medium- and high-voltage electric power grid (in some cases even into the extra-high voltage power grid). Currently, electricity generated from renewables accounts for more than 35% of Germany's annual electricity requirements in terms of gross electricity generation.

In 2000, wind turbines were being installed mainly on the North German Plain, and massive expansion of wind power is still ongoing there because the EEG subsidy mechanism provides particularly high incomes for wind turbines installed in this region. In the photovoltaic sector, the beginning of rapid growth took off around 2008, mainly driven by the massive drop in prices of PV modules manufactured in China. This led to new PV installations at a rate of around 10,000 MW per year, primarily household systems on roofs in southern Germany. When subsidies for open-range PV installations were mainly limited to military brownfield sites (which had previously been built upon, but were no longer in use), these were mainly installed in the former German Democratic

Republic (East Germany), where redundant military bases/airfields could be found. Some of these, located in Lusatia (German: *die Lausitz*), in north-eastern Germany, benefit from solar irradiation levels comparable to those situated alongside the river Danube in southern Germany.

From the point of view of the relation between renewable power generation and electric power demand from the consumer side, Germany can be divided into three general geographical regions:

1. In the south of Germany (Bavaria, Baden-Württemberg) there is now a very high installed capacity of PV, which naturally feeds into the power grid during the day; wind power, at only 3% of national total installed capacity, is *de facto* non-existent in this region. Electricity demand in this region is quite high, because of the high level of industrialisation and the household electricity demand of 28% of the German population living in this region. The risk of a temporary overfeed into the grid from renewables is therefore rather low, and small decentralised battery storage units as a supplement to roof-mounted PV systems could make a substantial contribution to grid stability.

2. In north-west Germany (Schleswig-Holstein, Lower Saxony, North-Rhine-Westphalia, Hessen, Rhineland-Palatinate, Saarland), about 52% of the German wind power capacity is installed. Containing 51% of total German population and its electricity demand, as well as high-energy-consuming industrial regions in the Ruhr and Rhine-Main regions, electricity demand is very high. The high renewable generation combined with the high power demand (often not occurring at the same time) puts severe pressure on the power grid operation. Large power-to-heat or power-to-gas plants could make an important contribution by removing temporary surpluses from the system.

3. In north-east Germany (Berlin, Brandenburg, Mecklenburg-Western Pomerania, Thuringia, Saxony and Saxony-Anhalt), can be found 45% of total German wind power capacity and the largest PV plants in the country – totalling up to 160 MW. There is a very low demand for electricity: only 21% of German total non-industrial electricity demand and low requirements for industry.

These discrepancies become particularly clear, for example, on the E.DIS grid network, the distribution grid operator in north-eastern Germany, supplying the area around Berlin and up to the Baltic coast, when the proportion of electricity consumed from renewable sources is compared with the volume of electricity sold onto the grid in the E.DIS power grid area (see Fig. 3.2.1.1.1).



Figure 3.2.1.1.1: Bar chart A: Renewable energy generated in E.DIS grid network region (red bars) is more than 100% of what the E.DIS grid extracts and distributes to end-users. The average for the whole of Germany is 33% (dark blue bars). Bar chart B: Installed renewable energy capacity in the E.DIS grid network region is greater than the peak load on the E.DIS by a factor of 4, and the baseload by a factor of 17. | Source: Prof. Dr. H. Schwarz, b-tu.de: e.dis. | Graphic: RENAC.

Since 2015, this ratio has been well above 100%. The installed renewable energy capacity in the E.DIS network exceeds the peak load on their power grids by a factor of almost 4, and the baseload on their grids by a factor of 17. Similar situations can be found in the MitNetz-Strom power grids in Brandenburg and Saxony-Anhalt, where on many grid sections the renewable energy capacity is also above 100% of peak loads; but this should not be confused with power grids fully and reliably supplied by renewables. On many days of the year either a huge renewable overproduction will occur or there is almost no contribution made by renewables to the electricity demand. This 100% figure only means that over the whole year the same volume of energy is generated by renewables that is needed by consumers; unfortunately the intermittent kind of renewable generation from wind energy and PV cannot match the demand from consumers minute by minute.

All in all, this has resulted in transmission and distribution grids often being operated at their load limits, and the transmission network of 50Hertz-Transmission GmbH, which is the North-East German TSO-Transmission System Operator, being subject to compulsory operational controls on more than 300 days per year and often several times per day. In addition to days on which the transmission grid operator requested feed-in adjustments (redispatch requests) from power plants in order to avoid or eliminate regional overloads, in the vast majority of cases renewable energy plants had to be switched off. And on the distribution grids, too, renewable energy plants are switched off more or less daily via grid safety systems when the current carrying capacity of lines is reached.

Energy storage is a possible solution to these problems on the north-east German transmission grid, operated by 50Hertz-Transmission GmbH, but it would need to be designed taking into consideration the magnitude of temporary overfeeds of power from renewable energy plants. During storm Xynthia in 2010, the entire 50Hertz network region area was 100% supplied by renewables; all conventional power plants were powered down to their minimum technically compatible outputs and, in total, there was a 200 – 250 GWh surplus. The largest German pumped-storage facility, Goldistal in Thuringia, has a storage capacity of 8 GWh. The total storage capacity of the network region of 50Hertz-Transmission GmbH is approximately 20 GWh, which corresponds to about 50% of total German storage capacity. By 2018, under usual wind conditions, sufficient power was being generated to oversupply the regional grids in north-eastern Germany several times a month, and to inject several hundred GWh from the 110-kV grid into the 400-kV transmission grid. As the number and capacity of renewable energy plants increases, the 400-kV power grid operated by 50Hertz-Transmission GmbH can only be kept stable if the grid is massively expanded so that it can feed surpluses generated by renewables to grids in the south and the west of the country. The commissioning of the south-west inter-regional transmission line (German: *Südwest-Kuppelleitung*) in autumn 2017 has relieved this situation to a certain extent; however, a further massive expansion of the national transmission network is necessary, combined with the construction of large energy storage facilities (pumped-storage facilities, compressed gas storage facilities, batteries) and controllable and flexible loads such as power-to-gas and power-to-heat facilities which can be used take excess power when it is available.

### 3.2.1.2 Demand side management

*Andreas Koch, Enrique Kremers*

Germany's climate-protection targets (see Chapter 2.1) have two interconnected consequences for the electricity network. Power plants and systems that generate electricity from renewable energy sources, such as the sun and wind, are increasingly replacing traditional, fossil fuel-based plants. These latter plants, which are dispatchable, have to date provided most of the generation-side flexibility (the ability to respond to varying electricity demand) required for the grid. Photovoltaic systems and wind power plants can only provide generation-side flexibility by being curtailed. This procedure is not efficient as the curtailed power is not utilised. Therefore, the integration of generation profiles generated by intermittent sources requires a larger demand-side flexibility which can avoid curtailments by absorbing the excess generation. In a future sustainable power system, supply and demand cannot be considered independently. Both need to be treated hand-in-hand to ensure a higher degree of flexibility of the energy system. With regard to industrial processes, as well as demand from buildings and residential households, 'demand side management' (DSM) can be employed. DSM allows for controlling electrical loads on the demand-side of the grid, which, within the context of renewable sources, means matching the demand for electricity with the intermittent supply from renewable resources, or with other economic requirements. In practice, this means that, depending on the current requirements, the demand from consumer loads is actively managed, i.e. switching loads off and on, or modifying their intensity. In addition to balancing electricity generation and demand, the flexibility enabled by DSM can also tackle grid congestion and voltage stability. Targeting local control of specific loads can reduce or fully avoid grid congestion, and thus can minimise the need for grid extensions. The flexibility enabled by DSM can provide an important contribution to the energy system's flexibility and can relieve the use of transmission networks. The comprehensive introduction of DSM requires the coordination of both distribution and transmission system operators; installations and consumers are mostly connected to the distribution system, but the responsibility for grid stability lies with the transmission system operators [6].

#### DSM in industry

In the industrial sector, the management of energy-intensive processes such as cement mills or electric industrial furnaces [7] can contribute to provide dispatchable loads on the demand side. DSM can be implemented in industry when load management – from load reduction to load shedding – makes economic sense for a company and does not



adversely affect the industrial process. In Germany, this has been practiced by industries with large, energy-intensive loads for some time now. However, DSM is largely unknown in many parts of the SME sector. With the increasing need for flexibility, an application of DSM to medium-sized industrial processes, which are time-uncritical and have low switching and coordination requirements, can contribute in an economically viable way to grid flexibility.

### **DSM in buildings**

There is also potential for load management in residential and non-residential buildings, especially with regard to electrical loads such as heat pumps or cold stores. DSM can be additionally enabled through heating and cooling applications via 'sector coupling' [4]. In addition to the management of pure loads, energy storage units and small-sized decentralised generation units at local level can also form part of an integrated DSM concept in order to contribute to the flexibility of the distribution grid.

Currently, one of the major challenges DSM is facing is the availability of bi-directional communication infrastructures and the associated capability of decentralised control in conjunction with aggregators, which are companies that manage demand by acting as an energy manager between higher-level actors in the energy system, such as utilities or energy markets, and consumers, by combining individual consumer loads. The latter refers to the coordination of relatively small individual loads which, being available in large numbers, aggregated together represent a considerable DSM potential. Several R&D projects [8] [9] are currently exploring the economic viability and integration options of these solutions into existing electricity markets [3][5].

#### **3.2.1.3 Mini-grids and renewables-based power generation**

*Andreas Wiese, Paul Freunsch*

Mini-grids are electrical generation and supply systems that consist of:

- power generation equipment to convert renewable/fossil primary or secondary energy into electricity (and may including energy storage)
- a distribution grid to deliver electric power to consumers, and
- any other equipment needed for the operation the mini-grid.



Figure 3.2.1.3.1: Example of a mini-grid with decentralised PV, wind turbines, batteries, a diesel generator and a distribution grid/network. | Source: <http://www.ennera.com/en/detail-solution/minigrids>.

They can be operated connected (in parallel) to a main electric power grid, or be off-grid or ‘in islanding mode’ (temporarily disconnected from the grid). This chapter focuses on mini-grids which generate power at least to some extent from renewable energy sources.

Mini-grids usually consist of the following components:

- a distribution grid (LV or MV) connected to consumers
- power generation equipment such as:
  - diesel generator sets
  - photovoltaic power plants
  - wind turbines
  - small hydropower turbines
- energy storage (e.g. batteries)
- a hybrid-power-plant control system.

The installed power-generation capacities of mini-grids have a wide range and there is no internationally accepted definition regarding their size. Some publications distinguish between nano-grids, microgrids and mini-grids. In general, nano-grids can be defined as having a power-generation capacity of less than a few kW (though also a grid serving a single building), microgrids up to several 100 kW, and above that, going up to 10 – 20 MW, the term mini-grid is used (though the term ‘mini-grid’ is also commonly used to describe what we have referred to as ‘microgrids’).

In general, the development, engineering and design of mini-grids follows the same principles as for other power sector projects. These are described in Chapter 4.

### **Mini-grids as a growing part of the transition to sustainable electricity**

Roughly 15% of the world’s population – more than one billion people – have no access to electricity. Since most of these people are living in rural areas without access to national electricity grids, one of the prime solutions for providing them with power is via mini-grids. In order to provide sustainable electricity to rural areas, especially in developing countries, these mini-grids should be based on renewable energy sources.

Additionally, there is also a growing tendency to add renewable energy sources to existing mini-grids that are currently fuelled by expensive and unsustainable fossil fuels such as diesel or heavy fuel oil. Their high fossil fuel prices are more often connected to logistics costs rather than world market prices for fuel.

### **Mini-grids versus grid extension**

Whether it makes more sense to extend an existing grid network to rural regions or to build a mini-grid depends on a number of factors:

- Distance to the grid and other factors determining the cost of connecting to the grid (topography, land/sea connection, etc.)
- Number of consumers to be connected and their density in the geographical area concerned
- Consumers’ needs and expectations
- Future development of the rural region (population development, economic development, etc.)
- Flexibility, cost and reliability of the power generation on the grid to be extended

- Availability of renewable energy resources.

## Opportunities through the deployment of mini-grids

Mini-grids have a number of advantages:

*Reliability of power supply:* Mini-grids can significantly increase the reliability of an electricity supply. Due to their size and the local-level ownership or management of the physical infrastructure, electricity theft (which is commonly associated with centralised grid systems) can be reduced.

The more energy sources used to power a mini-grid, the higher the security of supply usually is. Most mini-grids therefore use diesel generators, at least for backup purposes.

*Environmental benefits:* Renewable energy based mini-grids may offer significant improvements regarding the environmental impact of the electricity supply if they replace electricity powered by fossil fuels. Depending on the circumstances, the electricity supply can be satisfied almost entirely by renewable sources.

*Economic benefits:* In rural regions or on islands, renewables-based mini-grids often provide significant economic benefits compared to the use of other sources of electricity.

*Private sector development:* If properly planned, reliable mini-grids can provide for stable development of private sector enterprises that rely on having an electricity supply.

*Future potential connection to larger electric power grid:* Subsequent connection of a mini-grid to the grid network is usually relatively straightforward (technically).

*Long term price stability:* Due to their relative independence from fossil fuels prices, renewables-based mini-grids can provide a stable and future-proof electricity supply.

## Challenges for the large-scale deployment of mini-grids

The advantages of mini-grids have not, so far, led to their deployment in very high numbers in most developing countries. Although large mini-grid programmes are now under development and implementation in Africa, still most mini-grids installations have to date been installed in Asia (China, approx. 60,000; Nepal, India, Vietnam and Sri Lanka, 100-1,000 each). Most of these systems use diesel or hydropower and are run by public utilities.

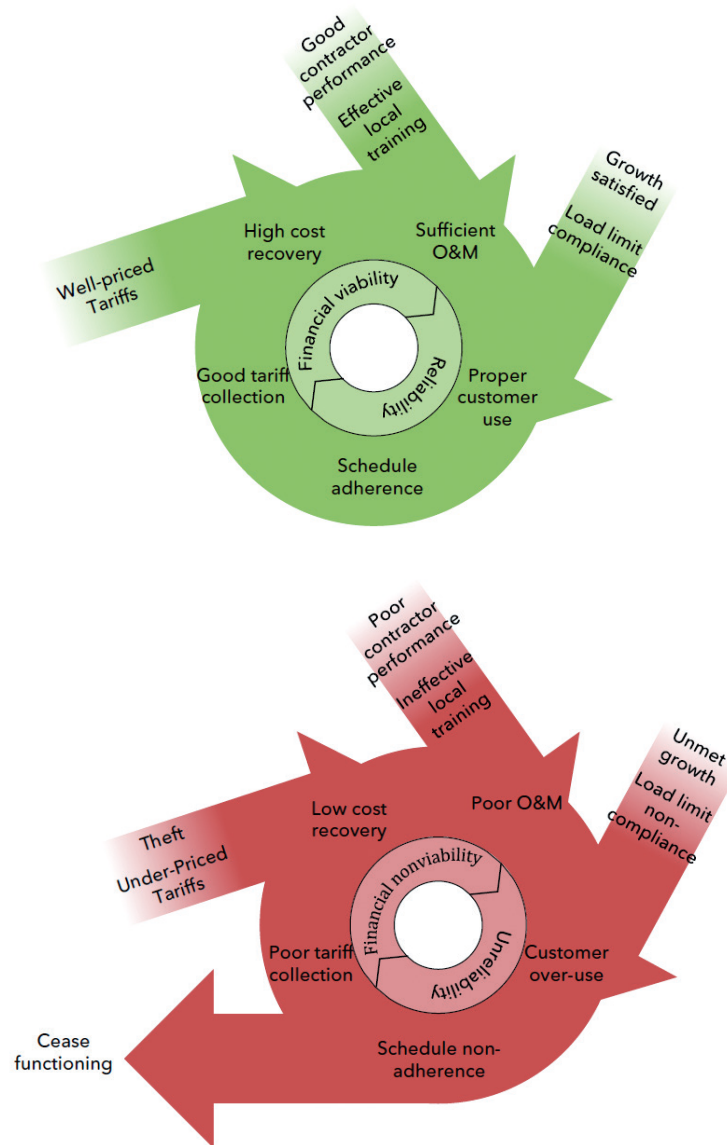


Figure 3.2.1.3.2: The so-called ‘virtuous’ (above) and ‘vicious’ (below) circles of positive and negative technology-human interactions that impact on the success or otherwise of micro/mini-grid projects. | Source: Microgrids for Rural Electrification, United Nations Foundation, February 2014.

Common challenges facing the large-scale deployment of mini-grids include:

*Demand assessment:* It is vital for the design of a mini-grid that the electricity demand is properly assessed. This is challenging, since mini-grids are usually based in areas where such data is not readily available and/or difficult to assess.

Technical components		Assumptions		Economic data	
Component	Size	Category	Assumption	Initial CAPEX	3.3 Mio. EUR
PV	1 MW <sub>p</sub>	Global horizontal irradiation	2,200 kWh/m <sup>2</sup> *a	OPEX	0.4 Mio. EUR
Li-ion battery	1.9 MWh	Renewable energy fraction	70%	Levelised cost of electricity (LCOE)	0.33 EUR/kWh
Diesel gensets	400 kW	System reliability	High (> 98%)	LCOE for diesel only (as comparison)	0.55 EUR/kWh
		Diesel price	1.7 EUR/l		
		Discount rate	7%		
		System lifetime	25 years		

Table 3.2.1.3.1: Simulated prognosis for a mini-grid in East Africa.

*Lack of suitable maintenance personnel:* Expert knowledge is needed for the installation and maintenance of mini-grids. Suitably qualified personnel are often hard to find in rural areas. If local personnel are not properly trained during the implementation of projects, this can have a significant negative impact on the subsequent performance of systems.

*Regulatory framework:* In many developing countries there is no clear regulatory framework or policy for mini-grids, or these are still being developed; this is a significant barrier, especially for private project developers.

The success of mini-grid projects is largely depending on proper planning, design, installation and subsequent operation. How these variables are managed and implemented can lead to either a very positive or a negative outcome, as is shown in Figure 3.2.1.3.2.

### Example of a successfully implemented mini-grid project in Mauretania

Eight sites located in secondary towns in Mauretania are served by PV-powered mini-grids within small villages. In total, 16.6 MW have been installed, ranging from 1 MW to 3.4 MW per site. All sites are or will be also connected to diesel engines in order to provide electrical power after sunset. One site also has a small-scale wind park. The power stations are designed to be operated fully automatically as hybrid systems, with significantly lower diesel consumption than stand-alone diesel-only power stations.

The energy-yield forecast is around 31,100 MWh annually. Altogether, the projects will power around 39,000 homes, save up to 10.4 million litres of diesel fuel and displace up to 27,850 tonnes of carbon emissions annually.

### **Economic viability of renewable energy-based mini-grids**

Table 3.2.1.3.1 shows simulated estimates for a PV-diesel hybrid mini-grid in East Africa. The system has a total installed capacity of 1.4 MW. The solar energy fraction (annual average share of power produced by solar, also called the ‘solar fraction’) is 70%. The total CAPEX is around 3.3 million Euro and the levelised cost of electricity (LCOE) produced is around 33 euro cents per kWh (compared to an LCOE of 55 euro cents per kWh for a diesel-only power plant). Of course, the relationship between the LCOE of a hybrid system and that of a diesel-only system depends to a large extent on diesel prices over the lifetime of the project.

#### **3.2.1.4 Smart grids – intelligent networks in tomorrow’s energy systems**

*Julia Hage, Fabian Kuhn*

Intermittent energy production from renewable energy sources combined with the stochastic consumption patterns of different energy consumers – ‘stochastic’ means it can be analysed statistically but not be predicted precisely – implies radical changes for entire energy infrastructures and presents a great challenge. Scalable and practical solutions are needed in order to achieve the goal of a transition to sustainable energy within a foreseeable timeframe. In order to achieve this transition, intelligent cross-regional networking and control of energy production and energy consumption is required. The ‘smart grid’ concept is seen as an ‘enabler’ technology in the transition to future sustainable energy systems. With the increased deployment of renewable energy and the intermittent/fluctuating loads on distribution and transmission networks that this involves, there is an increased need for a largely automated, fast communication between these networks across all voltage levels.

#### **What is a smart grid?**

A conventional power grid can be considered to be a ‘smart’ grid when it is upgraded through communication, measurement, control, automation and IT components [10]. The aim of a ‘smart’ network is to collect real-time network-status data and intelligently control and use it in such a way so that the full potential of network capacity can be exploited.

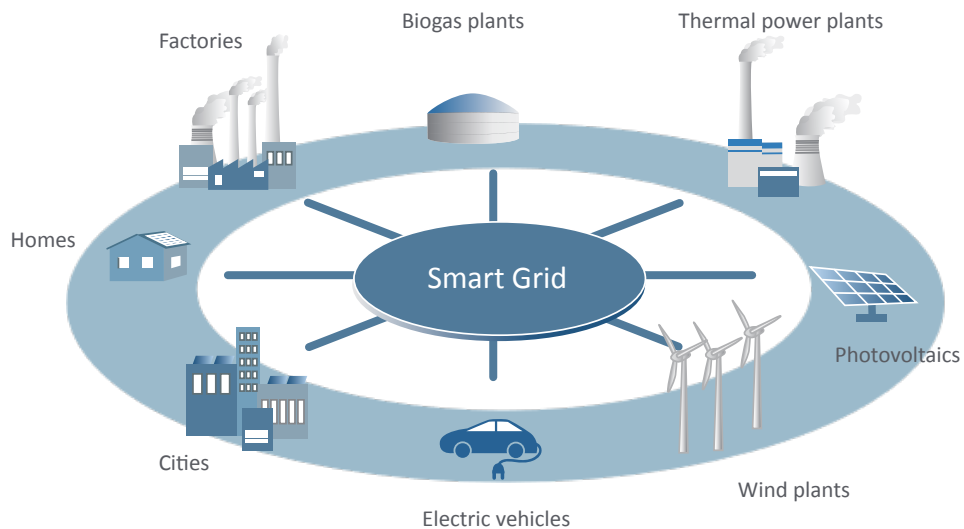


Figure 3.2.1.4.1: Smart grid and 'smart market' – with different renewable energy sources linked to a central co-ordinating platform. | Source: RENAC.

Such intelligent networking is not only a prerequisite for the integration of renewable energy into an energy system and a driver for energy efficiency at the final customer end, but also for the widespread use of electricity for mobility/transport applications.

### The role of the market mechanisms

The smart grid sector, compared to the current or conventional electricity industry, uses a wide range of new business models, some of which are based on novel and optimised value-added chains. A 'smart-grid market' can take the form of a digital platform that enables the flexible adaptation of power generation and power demand between all the parties involved in an energy system within a competitive framework. It is an 'intelligent' network that aims to tap previously unused power-generation and power-consumption flexibility potential and use the market mechanism to allocate this unused potential. The main characteristics of such a system are: decentralised power generation, decentralised control, and decentralised operation of power plants. In order to optimally exploit flexibility potential, electrical storage facilities can also be used as decentralised and flexible power providers.



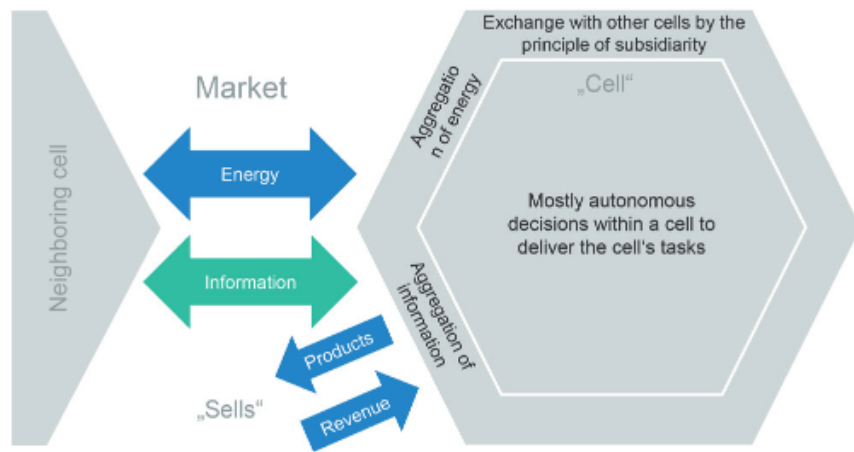


Figure 3.2.1.4.2: The structure of the 'cells' in the 'C/sells' project, illustrating how energy and information is exchanged and traded between the 'cells'. | Source: 'C/sells'.

### What does this mean for the energy sector?

The energy sector must gradually adapt to the entry of new players, some from outside the industry, while at the same time – despite changes, fluctuations and uncertainties – maintaining a stable energy supply. Market participants who understand digitalisation mechanisms and integrate them as core components into their business models have a good chance of being successful. However, only companies that have successful business models that are also compatible with the business models of other companies involved and with those of consumers, and together with them form a scalable and overall profitable system, can be economically successful.

### Achieving large and mass-market smart grids

It will take a while before large-scale and mass-market smart grids are deployed. Initial concepts are currently being researched in Germany. At the beginning of 2017, a total of five demonstration projects were launched; their duration is set until the end of 2020. The largest project spans the states of Baden-Württemberg, Bavaria and Hesse and is called 'C/sells'. The C in 'C/sells' stands for the individual 'cells' in the project region. Energy production and consumption is balanced (where this is possible) across the 'cells' in such a way that each 'cell' can obtain the energy services it requires from the overall infrastructure created by the other 'cells'; the system operates according to the principle of 'subsidiarity' (only those tasks which cannot be performed at the lowest level are

performed at a higher level). ‘Sells’ (from ‘to sell’) refers to new business models and the creation of new economic structures and opportunities associated with the digital energy transition. ‘C/sells’ is already demonstrating how the widespread implementation of the German ‘energy transition’ (transition towards sustainable energy) programme and the expansion of renewable energy generally can function on a large scale in the south of the country. A total of 56 science, industry and networking partners have joined forces to prepare the project for a successful mass-market rollout over a four-years period. The ‘C/sells’ project is based on the idea of intelligently linking the ‘cells’ of a diverse infrastructure into a network in which economic opportunities are reconciled with both physical constraints and the aim of managing economic activity in a sustainable manner. The ‘cellular’ approach enables untapped potential and local synergies to be systematically assessed and better deployed, and a robust energy infrastructure between the ‘cells’ and beyond them is created. The basic technology of most of the components and sub-systems have already been tested; and with the possibilities available within the framework of the German government’s Digital Agenda, it is possible to demonstrate how a secure and environmentally-friendly restructuring of the energy system can be achieved, within the context of the energy transition in southern Germany.

These pilot projects can be considered as a basis for the worldwide development and deployment of smart grids. This, however, requires increased communication and cross-border cooperation. Only thus will it be possible to roll out a smart grid across Europe or even worldwide, and fully exploit the great potential of these intelligent networks.

### **3.2.1.5 High-voltage DC transmission (HVDC)**

*Thomas Kraneis*

More than 260 GW of electrical power in the form of high-voltage direct current (HVDC) is being transmitted worldwide in more than 120 projects. The use of HVDC technology has grown spectacularly in China, India and South America in recent years. In the coming decades, the demand for HVDC networks will continue to rise; the international grid network not only requires the further expansion of renewable energy technologies, but there is also increasing demand – both technically and economically driven – by data centres for so-called ‘DC highways’. There is no economically viable alternative to DC transmission technology for transmitting electric power over long distances.

When the German engineer Oskar von Miller successfully carried out the first high-voltage direct current transmission from Miesbach to the Munich Crystal Palace over a distance of approximately 60 km to power a fountain there in 1881, interest in the possibility of

transmitting direct current over long distances spread quickly among engineers. For example, for four decades, engineers have been planning to transfer DC electricity from the large hydropower Inga power plants near Brazzaville/Kinshasa on the Congo river to South Africa, West Africa and Egypt. The final proposed Grand Inga, will have a capacity of 40 GW. 'Unlike Inga I with 6 x 58.5 MW, Inga II with a total of 1,424 MW, and the planned Inga III with up to 4,300 MW, and which are on Congo branch channels, the Grand Inga dam project plan involves a complete diversion and damming of Congo river. With a potential output of 39 – 45 GW, the dam would be the largest hydropower plant in the world, producing more than double the output of the Chinese Three Gorges Dam, and could cover much of Africa's energy needs. Its completion is expected to cost US \$ 80 billion. Inga I went into operation in 1972, and Inga II in 1982' [11].

Various studies in Europe, Russia and China show that HVDC is a practical economic solution for the long-distance transmission of electrical energy. However, HVDC technology is only economically viable above 500 MW. The advantages of HVDC transmission are the small land-area requirements related to line lengths, low transmission losses (only about 3% per 1,000 km), the contribution it can make to the stability of large electric grid networks, and the fact that no reactive power compensation is required in the long-distance DC lines. Reactive power is often necessary to neutralise phase shifts or to control the voltage in AC networks. The disadvantage of HVDC transmission is that the base costs for converter stations only become economically viable for longer distances – above 70 km at sea (submarine lines), and above at least 500 km for land-based lines.

#### Advantages of high-voltage DC transmission

- Undersea (submarine) power transmission over long distances possible
- Overland transmission with overhead or underground lines possible
- Combination of all of the three above-mentioned power transmission systems possible
- Transmission of more electrical power than is possible in AC networks with the same number of pylons/masts, and thus lower land-area requirements
- No reactive power compensation requirement for the actual line, which means cables can be used over long distances
- Compatible switching technology available
- Reduced insulation requirements
- Transmission of large amounts of electricity in both directions (back and forth) over long distances possible.

Disadvantages of high-voltage DC transmission:

- There is a lack of sufficient fast track DC power line projects
- Standardisation is still under development
- For the most part, only HVDC point-to-point connection is possible; therefore, there are currently no transmission networks.

Advantages of high-voltage three-phase transmission:

- Currently, the economically viable transmission of electrical energy up to about 600 km with overhead lines and up to 80 km with underground/buried lines
- Sophisticated transformer and circuit breaker technology is available
- Different transmission systems can be mixed.
- Standardised components are largely available
- The life of primary technology (cables, transformers, switchgear) is 40 to 80 years [10].

Since 1945, around 10,500 km of HVDC underground cable systems have been installed globally. The HVDC lines that are currently in operation are generally considered to be



Figure 3.2.1.5.1: New electric power grids in Europe. | Graphic: RENAC.



Figure 3.2.1.5.2: The SuedLink project – possible route for HVDC line. | Source: ILF Consulting Engineers. | Graphic: RENAC.

technical and commercial successes. Examples are: the NorNed HVDC line between Norway and the Netherlands; the line from Xiangjiaba to Shanghai, China; the €410 million 400-kV HVDC line between France and Spain; and the German NordE.ON 1, the first HVDC line connected to an offshore wind farm.

### Large HVDC projects being planned

The DESERTEC project, which aims to bring electricity from North Africa to Europe, plans to do so via HVDC lines from the MENA region to Europe. However, the project is currently stalled because of the politically unclear situation in the region. The German Lower Saxony state development ministry responsible for spatial planning completed the regional planning procedure for a German-Norwegian HVDC cable (NorGer) in the spring of 2011. The more than 600 km long submarine and land-based cable, with a transmission capacity of 1,400 MW, will transmit electricity from the southern tip of Norway at Kristiansand through the Skagerrak and the North Sea to Germany. The operational start,

which was originally planned for 2015, has been postponed to 2020 or later, because the southern Norwegian grid must first be expanded to meet the new requirements.

The Norwegian government has granted the licenses necessary for the construction of the power link, NordLink, between Norway and Germany, to the Norwegian transmission system operator Statnett. The necessary permits have also been granted on the German side. This is a German-Norwegian joint project in which both the Norwegian Statnett and German DC Nordseekabel GmbH & Co. KG each have a 50% interest. The 623 km long DC submarine cable will have a transmission capacity of 1,400 MW and is to be built by 2020.

From mid-2019, an HVDC line should connect the national electrical energy supply systems of Ethiopia and Kenya. The aim is to harness the great hydropower potential of Ethiopia for the entire region. The €610 million financing required by the Ethiopia-Kenya Power Systems Interconnection Project was largely provided by the African Development Bank and the World Bank. Construction of the more than 1,000 km long HVDC line began in September 2013. Completion is not expected before 2020.

### **SuedLink – a milestone project for Germany**

The SuedLink energy transmission project aims to supply electricity generated by wind power in the north of Germany to the south of Germany. The project involves laying HVDC transmission lines underground. The main reasons for laying the HVDC lines underground are:

- Low public acceptance of overhead lines by the general public
- High population density in areas which the lines cross
- The need for lines to cross environmentally-protected areas
- Security reasons.

The 700 km long transmission system will have a transmission capacity of 2 x 2 GW at a voltage of up to 525 kV. ILF Consulting Engineers has been appointed the client's engineering consultant and, as the lead partner in the consortium responsible, has received the contract to draw up plans for official approvals. Commissioning is planned for 2025.

## Growing need for HVDC lines

Developing a unified approach to the construction, expansion and financing of HVDC projects at European level is difficult. Policy discussions in Brussels can be time-consuming due to differing national interests – although there is no doubt, technically, regarding the need for further HVDC lines. The plan is to trade electricity across Europe via interconnected connected HVDC lines, in response to demand.

This demand is driven by the growth of data technologies. Around 12% of German electricity consumption is already required for the operation of electronic data-processing devices. According to a report by Greenpeace USA, cloud services consumed 684 TWh of energy in 2011 (most recently available figures). By 2020, the electricity consumption of internet activity is set to be three times that. Apple, Facebook, Google and SAP also aspire to power their data centres and offices exclusively with 100% renewable energy, another reason why the future-oriented expansion of HVDC is a sensible investment. Large data centres now require 100 MW DC power per units. German data centres currently only consume 3% of German electricity, but demand is constantly increasing [12] – [16].

### 3.2.2 Gas networks – as distribution and storage facilities for renewable energy

*Michel Kneller*

Because of their size and large storage volume, natural gas networks are particularly important for the transition from fossil fuels towards renewable energy. Electricity produced by intermittent energy sources such as solar and wind can be converted into hydrogen by electrolysis; and it is possible to feed this hydrogen into existing gas networks in limited quantities and to mix it with the natural gas. Another option is to convert the hydrogen to methane via CO and CO<sub>2</sub> methanation (see Chapter 3.3.4.2 Methanation). This ‘power-to-gas’ process is still being developed, but in the future it could avoid the need to limit output peaks in solar and wind farms; significant amounts of energy (which would otherwise not be used) could be temporarily stored in the form of gas in the existing gas pipeline network and storage facilities, and eventually delivered to consumers. Globally, there is a gas pipeline infrastructure of approximately 2.9 million kilometres. In the USA alone, there are approximately 2 million kilometres [16]. The pipeline lengths given in Figure. 3.2.2.2 represent only the main gas connection lines (distribution lines to final consumers are not shown). These pipelines have enormous potential – depending on their pressure ratings and diameters – for transporting and storing gas (and therefore energy). The German gas network alone has a storage potential of approximately 130 TWh [26]. The global gas pipeline network and the large number

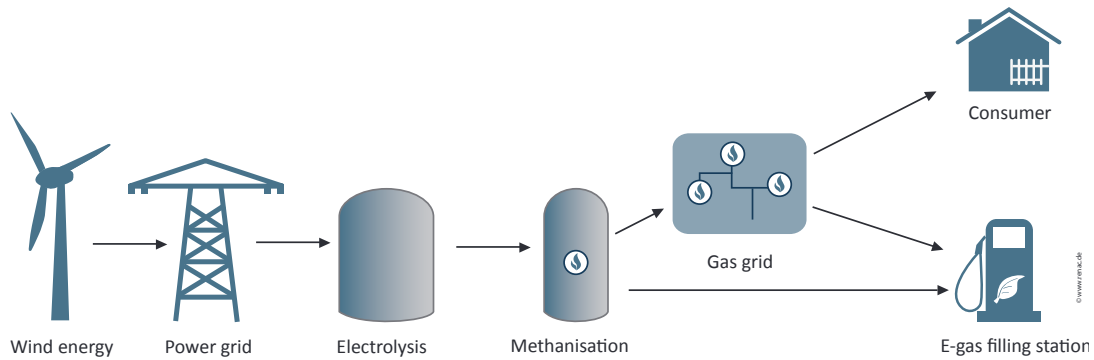


Figure 3.2.2.1: Storage and distribution of renewable energy. | Source: RENAC.

of underground gas storage facilities around the world have a total storage capacity of approximately 430 billion standard cubic metres [23], and in the future could be used both for the storage and transport of energy generated from renewable sources. However, to integrate renewable energy into existing gas networks and storage facilities, network operators need to be prepared to respond to the naturally occurring variations in gas production from intermittent renewable energy sources such as wind and solar. Gas production based on renewable energy (it is produced when excess power is available; and which will also result in electricity generation peaks) will be far more intermittent than is the case now.

When feeding a gas into an existing natural gas network, a distinction is made between ‘substitute gases’ and ‘additive gases’. A ‘substitute gas’ is a gas which can be used as a substitute for natural gas, also called ‘substitute natural gas’ (SNG). An ‘additive gas’ may

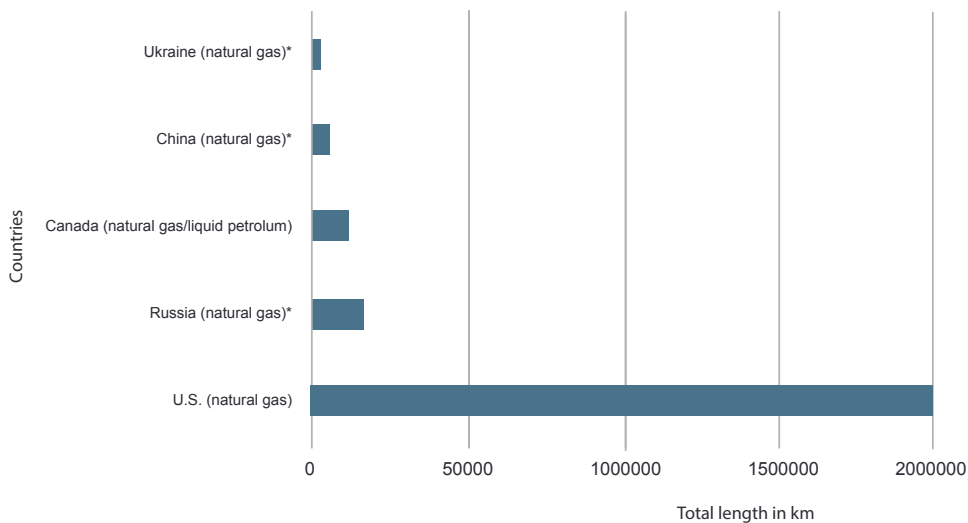


Figure 3.2.2.2: Gas pipelines worldwide in kilometres. Source: statista.com [15].



only be fed into the network in limited quantities. So, for example, when hydrogen (classified as an ‘additive gas’) is fed into an existing natural gas network, certain limits must be observed. The hydrogen will, among other things, have a direct influence on the calorific value of the gas mix and its Wobbe Index range. (The Wobbe Index is an indicator of the interchangeability/quality of fuel gases.) The German DVGW regulations, for example, allow hydrogen to be fed into an existing natural gas network only in the mid-single-digit percentage range, while DIN standard 51624 (replaced by EN standard 16723) allows up to 2% by volume to be injected. However, methane produced by methanation, following appropriate processing, is classified as a ‘substitute natural gas’ and can be fed into an existing natural gas network without restriction.

### **3.2.3 Heating and cooling networks**

*Arno Stomberg*

To achieve the German goal of reducing greenhouse gas emissions by at least 80% by 2050, the efficiency of the production of electricity and heat must be significantly improved. The increased use of combined heat and power plants (CHP) can make a significant contribution here. To improve the use of the heat energy generated, local and district heating networks urgently need to be expanded. Local heating networks transport heat energy over relatively short distances, while district heating networks transport heat, often generated as co-product by CHP plants, over greater distances. In heat distribution networks, heat generated centrally in a conventional CHP plant or in a biogas- or biomass-powered CHP plant, for example, is supplied to consumers to be used for space heating, water heating or as process heat in an industrial plant. The heat carrier is usually treated water, though – depending on the temperature of the heat generated and the demand from the customer requirements – steam can also be used. The heat distribution takes place via a piping system with supply and return lines. The heat is transported to the consumer(s) via a supply line and subsequently transferred to consumer’s heating system network either directly or indirectly via a heat exchanger. The water (now cooler) flows back via the return line to the heat generator, where it is reheated. The network is a closed circuit. Heat distribution networks usually consist of thermally insulated pipes – typically steel pipes with a thermal insulation of hard foam and an outer sheath made of PEHD. Temperatures range up to 140°C. At lower temperatures, up to approximately 80°C, flexible plastic pipelines can be used. Double pipe systems, in which the supply and return lines are combined in one pipe, are also possible in the low temperature range; their use can significantly reduce installation costs. The economic viability of heat distribution networks is determined by fuel costs, the length of supply and return lines, and the linear heat density (LHD) of the distribution

network (LHD is defined as the heat delivered per year per unit of length of the distribution system).

Buildings with continuous heat demand are well suited for local heating networks. These include:

- Swimming pools
- Multi-storey residential buildings
- Office buildings, hospitals, schools, administration buildings
- Densely inhabited residential areas
- Businesses.

However, local heating networks to new buildings, 'passive' houses/buildings, and buildings very far away from the source of heat, are generally not an economically viable option. The heat supply to buildings is arranged via heat supply service contracts. Heat delivered via a distribution network can also be used to run adsorption chillers (a generator of cooling for buildings powered by heat – as opposed to an electrically operated compression air-conditioning system). The cold generated by the chiller is transported to where it is required via an appropriately-sized network. To be economically viable, this type of cooling system requires a high and preferably continuous cooling demand. The use of this type of cold-generation means that heat distribution networks (with heat generated, for example from a CHP plant) can also be operated at times of the year when heat demand is low but cooling demand is high.

Within the context of the German energy transition from fossil fuels and nuclear towards renewable energy, CHP systems can optimise the production and consumption of energy for heating and cooling. The German Combined Heat and Power Act (KWKG) promotes the construction and expansion of heating and cooling networks. A 2017 amendment to this legislation set up tendering procedures for CHP plants with outputs of 1 – 50 MW. Furthermore, related sections of the German Renewable Energy Sources Act (EEG) and the Renewable Energies Heat Act indirectly promote heat distribution networks. There are currently several funding programs (providers include KfW, BAFA, BMWi). Since 2017, heat distribution networks (complete systems) have been, for the first time, eligible for subsidies.

## References

- /1/ Bundesnetzagentur (Federal Network Agency).
- /2/ Matschoss, Patrick; Bayer, Benjamin; Thomas, Heiko; and Marian, Adela, The German incentive regulation and its practical impact on the grid integration of renewable energy systems, *Renewable Energy*, Vol: 134 (2019), Page: 727-738, paragraph 3.3.1, Elsevier (2019) <https://www.sciencedirect.com/science/article/pii/S0960148118313090>.
- /3/ BMUB (2016): Klimaschutzplan 2050. Klimaschutzpolitische Grundsätze und Ziele der Bundesregierung. Online: [http://www.bmub.bund.de/fileadmin/Daten\\_BMU/Download\\_PDF/Klimaschutz/klimaschutzplan\\_2050\\_bf.pdf](http://www.bmub.bund.de/fileadmin/Daten_BMU/Download_PDF/Klimaschutz/klimaschutzplan_2050_bf.pdf).
- /4/ BMWi (2016): Grünbuch Energieeffizienz. Diskussionspapier des Bundesministeriums für Wirtschaft und Energie. online: [https://www.gruenbuchenergieeffizienz.de/fileadmin/redaktion/Energieeffizienz/bmwibro\\_gruenbuch\\_energieeffizienz\\_web\\_bf.pdf](https://www.gruenbuchenergieeffizienz.de/fileadmin/redaktion/Energieeffizienz/bmwibro_gruenbuch_energieeffizienz_web_bf.pdf) [14.06.2017].
- /5/ BMWi (2016c): Impulspapier Strom 2030. Langfristige Trends – Aufgaben für die kommenden Jahre. Online: [https://www.bmwi.de/Redaktion/DE/Publikationen/Energie/impulspapier-strom-2030.pdf?\\_\\_blob=publicationFile&v=21](https://www.bmwi.de/Redaktion/DE/Publikationen/Energie/impulspapier-strom-2030.pdf?__blob=publicationFile&v=21) [14.06.2017].
- /6/ dena (2016). Roadmap Demand Side Management - Industrielles Lastmanagement für ein zukunftsfähiges Energiesystem. Berlin, Deutsche Energie-Agentur GmbH.
- /7/ ECOFYS (2014). Flexibility options in electricity systems, report for the European Copper Institute, Köln
- /8/ SIM4BLOCKS (2018). Sim4Blocks Project funded by the European Union's Horizon 2020 research innovation programme under grant agreement No. 695965. Online: <https://www.sim4blocks.eu/>.
- /9/ SOLAR (2018): Demonstration und Durchführbarkeitsstudie für ein neuartiges System zur Realisierung hoher Quoten der Einspeisung, fluktuierender erneuerbaren Energien ohne Lastgangmessung im Stromnetz (SoLAR). Landesanstalt für Umwelt, Baden-Württemberg. Online: <http://fachdokumente.lubw.baden-wuerttemberg.de/servlet/is/126531/?COMMAND=DisplayBericht&FIS=203&OBJECT=126531&MODE=META3>.
- /10/ „Smart Grid“ und „Smart Market“ Eckpunktepapier der Bundesnetzagentur zu den Aspekten des sich ändernden Energieversorgungssystems. (Dezember 2011).
- /11/ <https://de.wikipedia.org/wiki/Inga-Staudamm>
- /12/ Liste der HGÜ Anlagen, [https://de.wikipedia.org/wiki/Liste\\_der\\_HG%C3%9C-Anlagen](https://de.wikipedia.org/wiki/Liste_der_HG%C3%9C-Anlagen), 9. Juli 2018.
- /13/ List of HVDC projects (English), [https://en.wikipedia.org/wiki/List\\_of\\_HVDC\\_projects](https://en.wikipedia.org/wiki/List_of_HVDC_projects) (14 Feb. 2019).
- /14/ Greenpeace, 2014: Clicking Clean: How Companies are Creating the Green Internet.
- /15/ AEE, Agentur für Erneuerbare Energien e.V., Atlas of the Energiewende – *The Energy Transition in Germany, 2030*.
- /16/ *Pipelines, CIA Factbook*, <https://www.cia.gov/library/publications/the-world-factbook/fields/2117.html>.
- /17/ <https://www.statista.com/statistics/267883/total-length-of-planned-product-pipelines-since-2010/>
- /18/ [https://www.gie.eu/conference/USB/GIE/GIE\\_Brochure\\_Towards\\_the\\_Paris\\_Agreement\\_March2018.pdf](https://www.gie.eu/conference/USB/GIE/GIE_Brochure_Towards_the_Paris_Agreement_March2018.pdf).
- /19/ [https://www.gie.eu/conference/USB/GIE/GIE\\_Brochure\\_Towards\\_A\\_Sustainable\\_Future\\_March2018.pdf](https://www.gie.eu/conference/USB/GIE/GIE_Brochure_Towards_A_Sustainable_Future_March2018.pdf).
- /20/ <https://www.bmwi.de/Redaktion/DE/Artikel/Energie/gas-erdgasversorgung-in-deutschland.html>

- /21/ <https://www.emw-online.com/ausgaben/5389/e-m-w/18/3/gruenes-gas>
- /22/ [http://publications.gc.ca/collections/collection\\_2018/cnrc-nrc/NR16-190-2017-eng.pdf](http://publications.gc.ca/collections/collection_2018/cnrc-nrc/NR16-190-2017-eng.pdf).
- /23/ <https://www.nrel.gov/docs/fy13osti/51995.pdf>.
- /24/ <http://www.cedigaz.org/documents/2017/Overview%20of%20underground%20gas%20storage%20in%20the%20world%202017%20v1.pdf>.
- /25/ [https://www.dvgw-ebi.de/download/ewp\\_1116\\_50-59\\_Kroeger.pdf](https://www.dvgw-ebi.de/download/ewp_1116_50-59_Kroeger.pdf).
- /26/ <http://www.stoffstrom.org/fileadmin/userdaten/dokumente/Veranstaltungen/EST/07.pdf>.

## 3.3 Energy storage

### 3.3.1 Mechanical storage

#### 3.3.1.1 Pumped-storage hydroelectric plants

*Annika Magdowski, Jerrit Hilgedieck, Martin Kaltschmitt*

Pumped-storage hydroelectricity (PSH) or pumped hydroelectric energy storage (PHES) represents the most significant and, to date, almost exclusively commercially available energy storage technology in the multi-MW range, and comprises 90% of the installed global storage capacity for electrical energy [1, 2, 3].

#### Technology and state of the art

Pumped-storage hydroelectric power plants typically consist of an upper storage reservoir and a lower basin. Between them is the powerhouse, where the pumps, including their motors, as well as the turbines connected to corresponding generators, are installed. The upper reservoir and lower basin are connected to each other via adequately dimensioned pipelines. The upper reservoir and lower basin can both either be natural geological formations or artificially created; combinations are also possible (for example, an artificially enlarged natural lake). Under certain conditions, a larger river with a sufficient flow of water can also serve as a lower basin.

Water is pumped via the pipelines from the lower level to the higher level, usually when electrical energy on the grid is available inexpensively and/or in excess. By this means, electrical energy is converted into potential energy which is then stored in the water in the upper reservoir. This energy can be stored for any length of time until it is needed (due to electricity demand and/or high market prices for electrical energy). It is then allowed to flow down the pipeline to the level of the lower basin via the turbines driving electric generators (see Figure 3.3.1.1.1) [4].

The potential energy ( $E_{ps}$ ) storable in the water of the upper reservoir is determined by the density of the water ( $\rho$ ), the gravitational acceleration ( $g$ ), the height difference between the upper reservoir and lower basin ( $h$ ), (the usable hydrostatic head) and the available volume in the upper reservoir ( $V$ ) (Equation 1). Using this equation, we can calculate that in systems with a height difference between the lower basin and the upper reservoir of around 300 m (an average for such plants) that 1 m<sup>3</sup> of water can store just under 1 kWh of energy [5, 6].

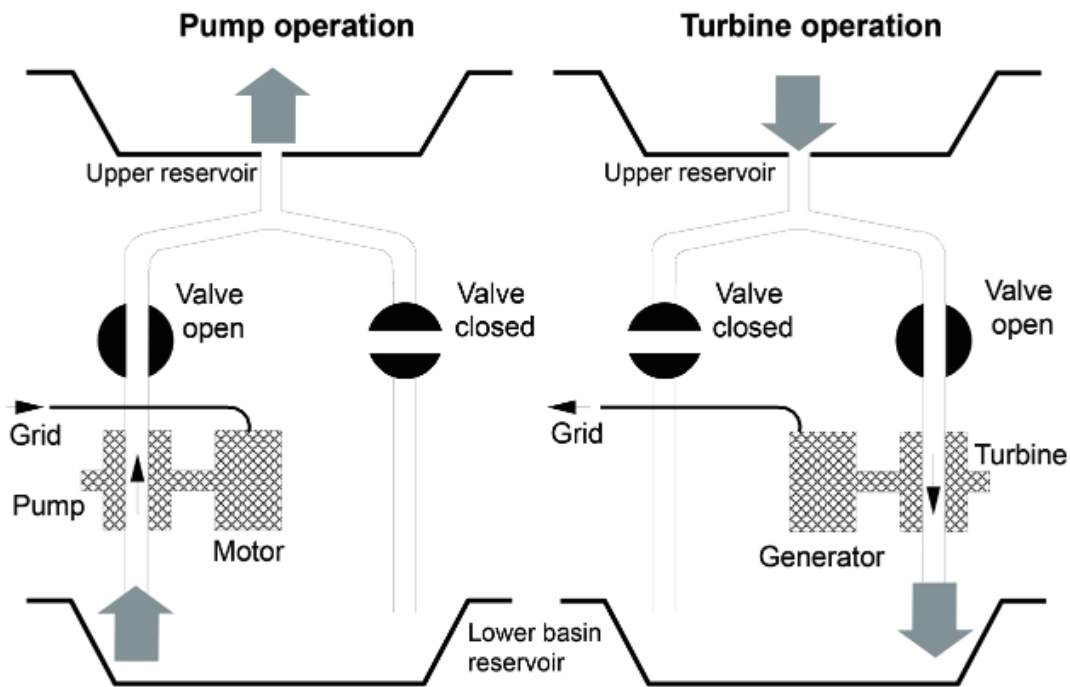


Figure 3.3.1.1.1: Operation of a pumped-storage hydroelectric plant. | Source: Springer Vieweg.

$$(1) \quad E_{ps} = \rho g h V$$

Thus, the electrical energy stored in such a pumped-storage hydroelectric power plant depends primarily on the size of the reservoir and the height difference between upper reservoir and lower basin. All these factors are significantly influenced by the topographical layout of a potential site, which can often only be adapted to a limited extent (such as by enlarging a lake which serves as a reservoir). Electrical pumping/generating capacity is determined essentially by the technically feasible flow rate in the pipeline (pipe diameter) and by the rated power of the pumps or generators.

System losses consist of pump and motor losses, turbine and generator losses, pipeline losses and water losses due to evaporation and water infiltration into the ground. The sum of total losses, means that the theoretical energy content of the pumpable water is reduced to

$$(2) \quad W_{ps} = E_{ps} \eta_{total}$$

which is a system's real working capacity. Today, larger, modern pumped-storage power plants can achieve efficiencies of around 80% under favourable topographical conditions. Due to the fact that the technology is mature and that some losses are physically unavoidable, this will not significantly improve [6]. Pumped-storage hydro power plants



sources into the grid – pumped storage plants have recently become less important in terms of the overall electricity supply system as a result of the expansion of power generation from photovoltaics. This is due to the current level of photovoltaic electricity in the system, which allows solar power to often almost completely supply daytime demand peaks (so-called peak shaving); the peaks that would otherwise have had to be covered by other power plants or PHES have correspondingly declined. As a result, the differential between peak and baseload electricity prices has also declined noticeably in recent years. However, this effect is likely to be reversed with further expansion of photovoltaic power generation. In a future that will be characterised by significantly higher shares of volatile feeds of wind and solar power into the grid, as long as other power-storage technologies are not yet technically mature and economically feasible, it can be expected that pumped-storage power plants will increasingly provide large-scale storage.

### **New economic frameworks for the electricity industry – market situation**

The economic framework that supported the traditional business model for pumped-storage power plants – taking advantage of the difference between electricity prices at times of high and low demand – is ceasing to exist in countries, such as Germany, which are increasing deploying volatile power generation sources [10]. This is due to, among other things, the general decline in electricity market prices in Germany since 2008 and the decreasing price difference between base and peak load electricity (due to the peak-shaving mentioned above). As a result, the provision of ancillary services to the grid becomes increasingly important for pumped-storage plants. But even in the market for the provision of control power, increasing competition from other providers is leading to falling prices for control power, so that the revenue opportunities continue to decline for pump-storage plants. But parallel to this, increased pumped-storage power plants operation to provide ancillary services – with corresponding heavier use of individual system components (pumps and turbines) – increases maintenance costs [10].

Average investment costs for pumped-storage power plants are estimated at around €500 to €1,000 per kW, but these costs are highly dependent on location and can vary considerably depending on local conditions, hydrostatic head, and the availability of natural basins/reservoirs (which also may need to be expanded) [1, 6, 11].



## Future developments

Currently, pumped-storage power plants are the only commercially available option for the very large-scale storage of electrical energy. As a result, they are indispensable for any power grid on which the share of volatile renewable energy generation is increasing and which aims to provide a high level of supply security. Therefore, where wind and solar power generation is being expanded, in order to ensure that pumped-storage systems are economically viable, the economic framework within which electric power is supplied to grid networks needs increasingly to change accordingly.

A total of around 14 GW of pumped-storage power plants is currently being planned or built around the world. The largest plant, with a capacity of 4 GW, is the 2016 Revelstoke Hydro Battery PSH project in Canada. Most of the plants currently being planned are located in North America [3]. The greatest potential for expansion in Europe is in Norway, where storage capacity could be expanded by about 84 TWh – and thus almost doubled [8]. But there is also potential for expansion in other European countries. For example, in western and south-western Germany, about 3.5 GW of power generation could be developed with a storage capacity of about 14 GWh [7]. However, due to the fact that currently the operation of pumped-storage power plants is potentially uneconomic, only a very limited further expansion in Germany can be expected in the near future. Expansion potential is also seen within the framework of the European grid network, in conjunction with the construction of high-voltage direct current (HVDC) transmission lines, in Switzerland, Austria, Norway and elsewhere; but this is more an option for the future.

Other approaches are also being considered. Smaller, decentralised pumped-storage power plants could be installed with underground basins/reservoirs (such as in former mines), at defunct opencast mining quarries or using tailing ponds. The possibility of converting existing hydroelectric storage power plants and run-of-river power plants by adding pumping systems is also being investigated; existing water storage structures and water courses upstream of dams could serve as (limited) reservoirs. These options would however bring only limited added overall capacity gains – and could, depending on the situation, involve considerably complex technical measures. In the longer term, pumped-storage power plants certainly have a future and will play an essential role in power supply systems to which an increasing amount of electricity generated from renewable sources is being added. However, the way it looks currently, existing worldwide pumped-storage power plants are not sufficient to meet the electrical storage requirements of electric power grids if, in the long term, power generation from volatile sources is increased by the addition of more wind and solar power. Other large-scale electricity

storage technologies will also need to be developed. These include both direct storage (e.g. batteries) and indirect storage (achieved by the interconnection of energy sectors).

### **3.3.1.2 Gravity storage**

*Reinhard Fritzer*

‘Gravity storage’ (German: *Lageenergiespeicher*), or ‘hydraulic energy storage’, is a new technical concept whose fundamental principle is based on storing energy via the lifting of a heavy mass of material into a higher position.

Various methods, research approaches, pilot projects, and project ideas exist, but it will take some time before they are ready for the market. Most approaches to date operate on the principle of lifting a solid mass (concrete, rock, etc.) by means of (hydraulic) pressure. The energy required to accomplish this is then stored as potential energy. In order to use this energy, the mass is subsequently lowered, releasing the energy, which is converted into electrical energy and fed into the electric power grid.

Gravity energy storage systems use hydraulic pumps to build up the pressure required to effect the lifting, and use turbines to convert the released potential energy into kinetic energy. There are parallels with pumped-storage technology; however, in pumped-storage power plants, the water itself, as it flows between reservoirs, acts as the energy-transporting medium. With gravity storage systems, the energy is usually transported via a piston or cylinder made of concrete, rock or other dense material. In order to lift this piston via the application of hydraulic pressure, the system needs to be ‘closed loop’ (via seals or similar).

Other approaches are also being investigated, for example, the use of hollow spheres in water reservoirs or on water surfaces (lakes / the sea), which, by means of compressed air filling or flooding an enclosed volume under pressure, can store and release energy. These systems also require pumps and turbines as well as appropriate sealing systems [12] – [16].

### 3.3.1.3 Compressed air energy storage

*Giw Zanganeh*

In compressed air energy storage, an electric motor operates a compressor to compress air to a desired pressure. This compressed air is stored in a storage facility – in a salt cavern, a rock cavern or a pressure vessel. When the energy is needed again, the stored compressed air is released to power a turbine which produces electricity via a generator and feeds the electricity back into the grid.

#### Diabatic (isothermal) compressed air energy storage

When air is compressed, heat is generated (as in the way a bicycle pump heats up). In a diabatic compressed air energy storage system, this heat is dissipated either while the air is being compressed or after it has been compressed. Since the resulting heat accounts for a significant portion of the energy used in the compression process (up to 60% of the electricity used), merely allowing the heat to dissipate reduces the overall efficiency of the system. In order to use the stored compressed air, it must be heated to increase its volume before it can be fed into the turbine; diabatic compressed air energy storage units use gas burning systems for this (see Figure 3.3.1.3.1).

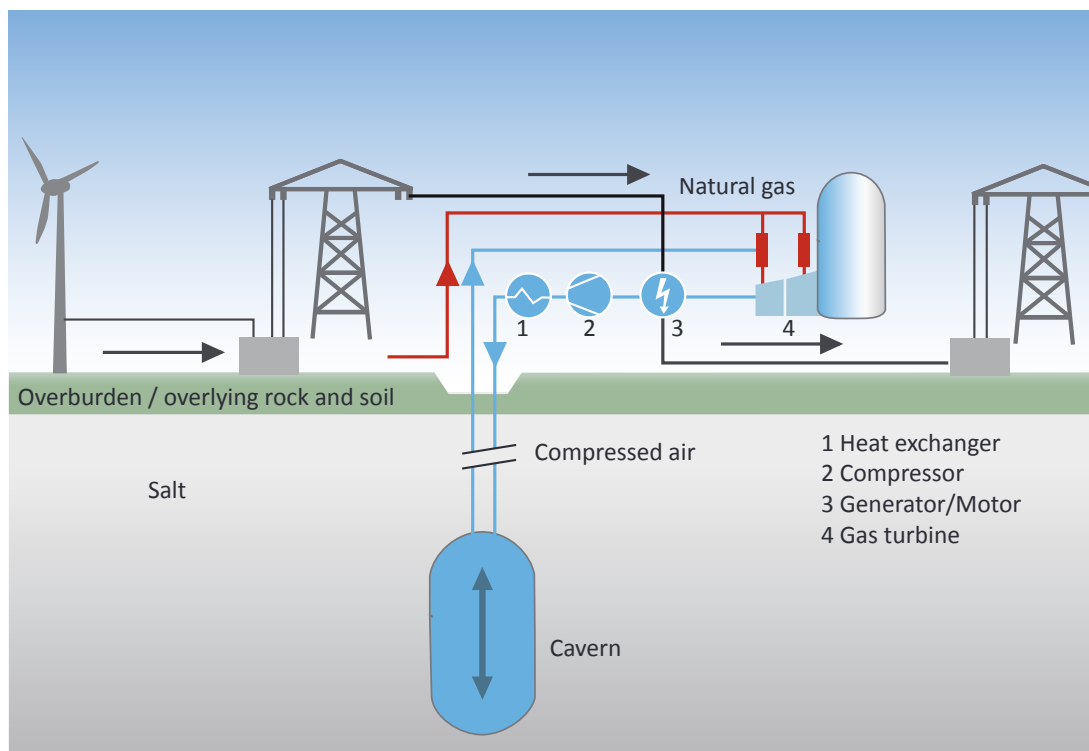


Figure 3.3.1.3.1: Schematic of diabatic CAES (compressed air energy storage) power plant. | Graphic: RENAC.

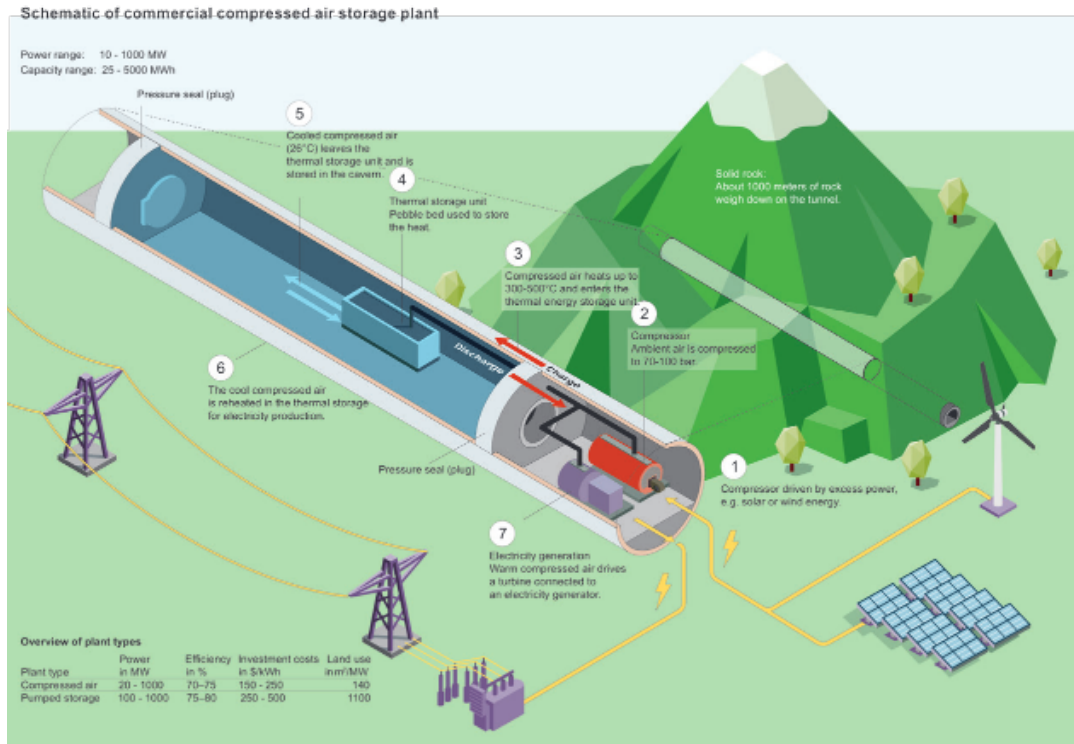


Figure 3.3.1.3.2: Schematic of a commercial adiabatic compressed air power plant. | Graphic: *Tages-Anzeiger* / ALACAES.

Presently, there are two up-and-running and commercially operated diabatic compressed air energy storage units. A plant in Huntorf, Germany has a capacity of 640 MWh with an operating efficiency of 40%; another plant in McIntosh, Alabama, USA, has a capacity of 2,860 MWh with an operating efficiency of 54% (with heat recovery). Both plants use underground salt caverns to store the compressed air. Research into the possible construction of another plant in Ireland is being carried out, also with a salt cavern as the storage facility.

### Adiabatic compressed air energy storage

In adiabatic compressed air storage, the heat generated during compression is not allowed to simply dissipate but is collected and stored. It is used to heat the compressed air before it flows into the turbine-generator (Figure 3.3.1.3.2), so no heating via gas combustion is necessary – unlike diabatic compressed air energy storage systems. This increases the total operating efficiency of adiabatic compressed air storage to 70 – 75%, and the generation of greenhouse gases (associated with the burning of fossil fuel gas) is thus avoided. An adiabatic compressed air energy storage pilot plant has been tested in the Swiss Alps – using a rock cavern as the pressure vessel and rock bed



Figure 3.3.1.3.3: Rock cavern pressure vessel access door. | Source: ALACAES SA.

thermal storage (Figure 3.3.1.3.3). However, adiabatic compressed air energy storage systems are not yet commercially available.

### Applications

Compressed air energy storage systems are best suited for storing large amounts of energy over several hours or days. Modular construction is not possible because of the required geological conditions and the type of large turbomachines required. Economic viability can only be achieved with large scale systems – with electric power capacities from about 20 MW upwards and storage capacities from about 50 MWh upwards.

A possible application of compressed air technology is, for example, in combination with solar or wind power plants. Adding energy storage capacity to these plants can help to adapt their power production to electricity network requirements/demand. It is also possible to use compressed air energy storage at strategic junctions to reduce loads on the electric power grid and avoid the costly grid upgrades/expansion.

### 3.3.2 Thermal storage

*Oliver Baudson, Jürgen Hogrefe*

Of all the thermal storage technologies currently available, large-scale thermal salt storage systems are the most significant in terms of industrial-scale use and maturity – especially in concentrating solar thermal power (CSP) plants.

#### Technology overview

Energy can be stored in a variety of very different ways (see Figure 3.3.2.1). ‘Latent heat storage’ utilises the property of substances / storage media (such as salt or paraffin) which can absorb energy during phase change processes at constant temperatures over a period of time (during melting or evaporation), or release it over a period of time (during solidification or condensation). ‘Thermochemical storage’ makes use of the effect in some chemical compounding or decomposition reactions by which high levels of thermal energy are absorbed (endothermic reactions) or released (exothermic reactions).

‘Sensible heat storage’ refers to heat storage achieved by increasing the temperature of a storage material/media. The material/media can be solid or liquid. Liquid media have the advantage that the liquid can be also be used to transfer the heat harnessed by the solar system directly into a storage unit. Large molten salt reservoirs are considered to be the state-of-the-art technology here. However, solid media storage units in which air is used as the heat transfer medium are also used ‘on the MW scale’. Research is also

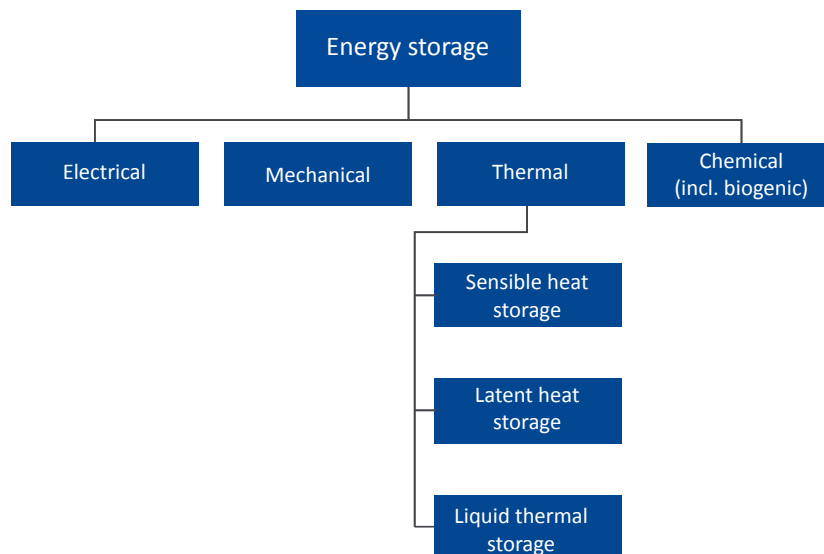


Figure 3.3.2.1: Thermal storage systems store energy in the form of heat. Biogenic means ‘of biological origin’; here, the reference is particularly to biomass feedstock. | Graphic: RENAC.

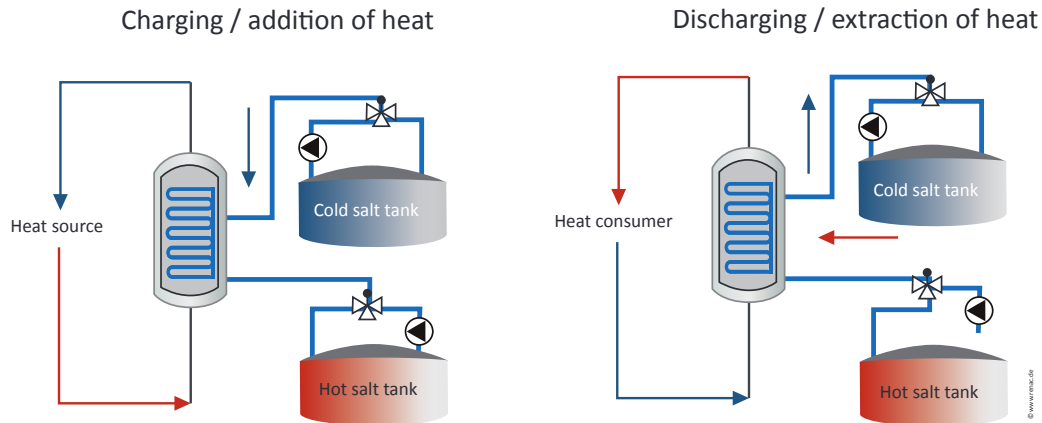


Figure 3.3.2.2: Operating principle of a thermal salt storage system. | Graphic: RENAC.

being carried out into storing high-temperature heat at a low cost in materials such as rock or ceramic particles (sand).

### Liquid thermal storage media (fluids) requirements

For industrial-scale applications, the requirements for liquid heat storage media are:

- The liquid must remain in a liquid state and be easy to pump across the entire operating temperature range. In solar thermal power plants, the lower temperature is that of the solar-heated water – typically, just under 300°C.
- The liquid must be chemically stable in the required upper temperature range, so that it does not degrade or otherwise deteriorate. The heat has to be transferred to hot steam (temperatures from 540°C to 620°C).
- The liquid should not develop any significant vapour pressures when hot, in order that the cost of the storage tank is not too high.
- The liquid must have low corrosiveness with regard to conventional building materials, especially with regard to steel – the less the (heated) liquid can chemically attack the materials containing it, the better (and the less expensive).
- A liquid with high specific heat capacity means comparatively smaller storage unit sizes, and thus lower costs. The heat capacity (or thermal capacity) is the ratio of the heat added to (or removed from) a substance to the resulting temperature change.
- Finally, the liquid should still be non-combustible, non-toxic, inexpensive and available in large quantities.

Nitrate salts, especially a mixture of sodium and potassium nitrate, currently meet the above criteria best. This salt is solid at ambient temperature, but liquifies at 223°C, and can be used up to about 565°C without decomposing.

### Operating principle and market status of thermal molten salt storage

To ‘charge’ (add heat energy to) the system, a heat exchanger transfers the thermal energy of the heat source via the heat-exchanger fluid (such as synthetic oil) to the liquid salt which is in a (relatively) cold salt storage tank. This is then pumped into a hot salt storage tank. To ‘discharge’ (extract heat energy from) the system, the salt flow is reversed. Hot salt flows to a heat exchanger which is located between the hot and cold salt storage tanks; there it releases its thermal energy, which in turn flows to a heat consuming device/system/load or to another heat transfer medium.

During the ‘charging’ process, the solar collector or solar receiver serves as the heat source. The heat transfer medium, an oil, transmits the heat energy which has been harnessed to a heat exchanger which, in turn, transfers the heat energy to the salt. The heated salt is stored in a hot salt tank until the ‘discharging’ process begins. When ‘discharging’, the salt transfers its heat energy back to the oil. During the discharge process, the solar collector or solar receiver is decoupled (via valves) so that the oil can transport the heat energy (thermal energy) to another heat exchanger, one which vaporises water to produce steam and drive a steam turbine to generate electricity (classic water/steam cycle).

Parameter	Comments
Location	In principle freely selectable, no major environmental impact, low land-area requirement.
Charging methods / capacities	Electrical or thermal, freely scalable, realised industrial performance ranges are between 50 and 200 MW.
Storage capacity	Freely scalable, realised capacities of between 500 und circa 5,000 MWh (thermal)
Utilisable temperature range (salt)	200 – 560°C
Life cycle	Nearly unlimited, no moving parts / no wear and tear (> 30 years), no degradation as with batteries.
Costs	Highly dependent on specific application (solar thermal power plant type, etc.) and on system size, but significantly lower than the costs of other systems in the above mentioned performance/capacity range.

Table 3.3.2.1: Overview of main characteristics of molten salt storage system.



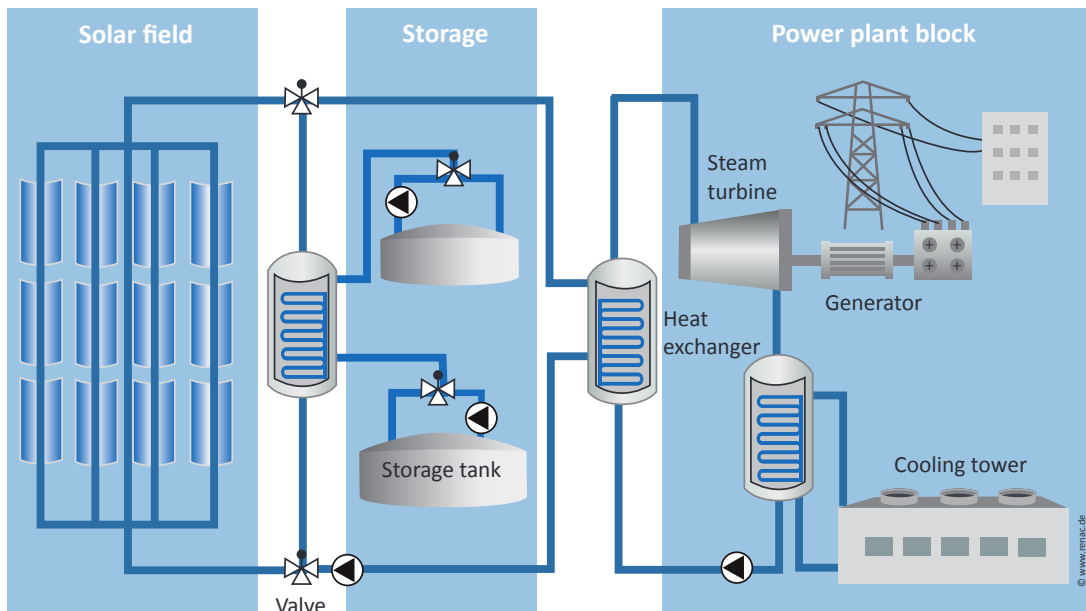


Figure 3.3.2.3: Schematic diagram of a large solar thermal power plant. | Source: RENAC.

Salt storage tanks are currently used in numerous solar thermal power plants worldwide. They store considerable amounts of thermal energy daily; and this stored energy is used to generate power when sufficient solar energy is not available – such as after sunset, during cloudy periods or during sandstorms.

### Potential – technical and economic

Intensive research is being conducted into storage materials that could be used as alternatives to the molten salts currently in use. The objective is, on the one hand, to enable higher temperatures (if possible, without degradation effects); this would lead to higher efficiencies in the power generation capacity of the stored heat. And on the other hand, process integration should be easy and the efficiency of the storage system should be high; lower solidification temperatures of new salt mixtures, for example, could contribute to this. In addition, the storage materials used should cost less.

Intensive research into process optimisation is also being carried out. In particular, a switch to single-tank systems promises considerable potential for cost savings. In this set-up, cold and hot salt are stored in a single tank, which is possible due to temperature-related density differences. Cost-effective filler materials – such as rocks – could partially replace molten salt in such single-tank systems.

## Future developments

Technically, it seems quite feasible to use thermal storage systems as ‘batteries’ (electricity → heat → electricity) to act a storage buffer for ‘surplus electricity’, though at first sight the lower power (re)conversion efficiency due to the Rankine engine cycle appears disadvantageous. Practicably, for the foreseeable future, it is unlikely that a functionally comparable battery system (in terms of performance and capacity) can be commercialised at sufficiently low cost and environmental footprint to compete with molten salt storage systems. Currently, the alternative to storage is not to use the surplus power, instead turning wind turbines out of the wind or powering down PV systems. Occasionally, in Germany, surplus electricity is even exported, with the exporter also paying for its disposal – to the detriment of electricity consumers who eventually must cover the cost of the production of the electricity in the first place. A schematic of a potential electric heat storage system with reconversion to electrical energy is illustrated in Figure 3.3.2.4. This system can be charged with surplus electricity (for example, from photovoltaic or wind power plants) but also with waste heat from industrial processes. When needed, the stored heat can be delivered to a power plant which uses it to generate electricity for the grid. These electric heat storage systems with reconversion could even be used to phase out coal-fired power generation in many cases. Initially, coal-fired power plants would be supplemented by a heat storage unit of suitable size to enable the operation of the coal-fired power plant to be more flexible. For example, the following set-up is conceivable: at times of the day when there is low electricity demand, electricity being fed onto the grid feed could be reduced and part of the heat energy generated by the coal could be stored. In periods of higher power demand, the stored heat would be converted into electricity.

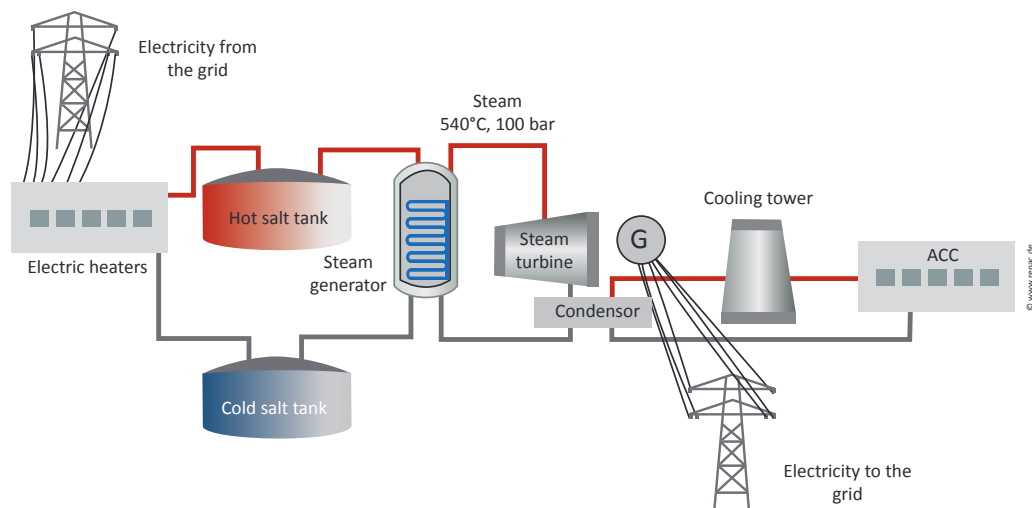


Figure 3.3.2.4: Electric heat storage system with reconversion to electrical energy. | Source: TSK Flagsol Engineering GmbH.

Subsequently – for example, when taking the political decision to phase out the operation of coal-fired power plants entirely – electrical heating systems powered by renewable energy could be added, with storage capacity accordingly expanded, and the coal combustion plant dismantled. The power plant generators would be kept in use and would continue to operate using the heat from the storage system. Thus, the coal-fired power plant could be converted to large-scale industrial heat and power storage and provide related grid services (e.g. frequency stability etc.), enabling the further expansion of renewable energies, and thus sustainably supporting the implementation of a transition to sustainable energy. Jobs would be largely secured.

### **3.3.3 Electrochemical energy storage**

#### **3.3.3.1 Batteries for households and electric vehicles**

*Jens Kottsieper, Manuel Seidenkranz, Steffen Rauer*

In some countries, governments and the automotive industry are investing billions of euros to promote the expansion of electromobility. Over the next few years, large quantities of electric vehicle batteries (EVBs) will be required. However, the storage capacity of these batteries decreases after five to ten years of use, to such an extent that they will no longer be suitable for use in electric vehicles. Usually, an electric vehicle battery is considered to have met the end of its working life when it has reached 70% of its original capacity. But deploying these batteries in less demanding stationary applications would mean that their remaining capacity could still be utilised and their working lives could be extended by more than eight years. In this way, overall battery costs could be reduced and the environmental impact associated with used batteries mitigated. The batteries could be reused, depending on the application, until they have reached 50% and below of their original capacity, before they are recycled. However, some technical hurdles remain to be overcome first. After their first life as electric vehicle batteries, the batteries must be disassembled, checked, sorted and reassembled. Due to the range of different types and lack of standardisation, their reuse is complex and costly.

One attractive application for reused electric vehicle batteries is in households, where they can make the ‘self-consumption’ of electricity generated by household photovoltaic systems, for example, more economically viable. Although homeowners would have to make an additional investment to pay for the batteries, they would be able to use a higher proportion of their self-produced electricity [17] – [21].

### 3.3.3.2 Batteries for system stability

Philip Hiersemenzel

In terms of power lines, Germany is in the centre of Europe. To date, this has helped Germany a lot during its transition towards renewables. Due to this central location in the European electric power network, grid operators in Germany can ‘push’ surplus electricity into the power grids of neighbouring countries. However, as the figures show more clearly every year, this is both inefficient and quite expensive. *De facto*, Germany gives away most of this electricity that it cannot utilise in its own electric power grids – and, increasingly often, the country even pays (high) prices to neighbouring countries to take this surplus electricity.

The background to this is as follows. At times of these ‘negative’ electricity prices and surplus electricity, the problem is not *per se* with the amount of electricity from renewables that is produced, but with the fact that 20 GW of conventional power plants continue to produce price-inelastic electricity even though this electricity is not needed. No amount of power grid expansion will resolve this basic problem. So the solution must be to turn off these large conventional thermal power plants – and with them their ‘spinning reserve’. But then what will supply the system services that guarantee grid stability (frequency regulation, voltage maintenance, reactive power provision and much more)?

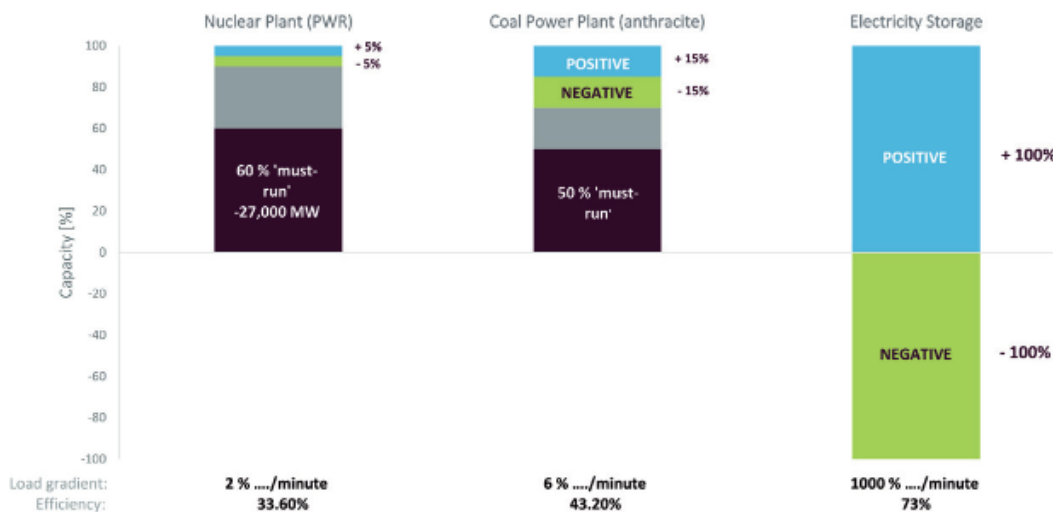


Figure 3.3.3.2.1: Energy storage is the key to downsizing the old energy mix in pace with the growth of the new. Batteries are by far the most efficient means of making the electric power grid more flexible. Batteries can deliver up to 100% of their capacity and react more rapidly by orders of magnitude – thus reducing the requirement for control power reserve capacity.

Large batteries could be the solution to this problem. Studies have even confirmed that high-capacity, short-term, energy storage facilities could replace up to ten times the conventional minimum power output required for control power (regulating power and balancing power), because they can deliver up to 100% of their capacity in two directions (putting power onto the grid and taking power from the grid), responding to requirements with precise accuracy [22]. Conventional thermal power plants, on the other hand, can deliver only a few percentage points of their capacity as control power – and not particularly precisely either (see Figure 3.3.3.2.1).

An example: Germany's first commercial 15 MW battery storage facility in Schwerin has rendered superfluous a fossil fuel powered plant with a capacity ten times larger, that had been used to provide system stability. Currently, Germany has just under 620 MW of primary control power reserve capacity, and just under 1,800 MW of secondary reserve capacity – to provide which a good 20,000 MW of power plant capacity is required to be available. If Germany's entire primary reserve capacity were to be provided by batteries, it would no longer need the 20,000 MW output from coal and nuclear power needed for system stability.

That large battery storage systems can be viable is supported by the dena study 'System Services 2030' which was conducted at the beginning of 2014 [23]. According to the experts' calculations, the installation of battery storage systems with a total capacity of 551 MW could save €241.6 million annually from 2030 onwards, compared to conventional grid control. If the transition towards renewable energy is to be kept affordable, the fossil-fuel and nuclear component must be reduced in pace and in conjunction with the addition of new renewable energy generating capacity. Battery storage can make an important contribution to reducing conventional minimum generation requirements and thus reducing costs.

## Remuneration

So technically, large batteries make sense, but are they economically viable – not only macro-economically (on a national level), but also micro-economically (on the enterprise/business level)? Unfortunately, the structure of the market in Germany for grid services / reserve power lags behind internationally. While elsewhere, especially in the UK and parts of the USA, speed and precision are rewarded, the use of large electrochemical energy storage units in Germany is still disadvantaged in many respects. In Germany, explicitly grid-servicing batteries are also still classified as end-consumers, not as elements of a decentralised, smart grid. And even if battery storage facilities are granted

exemptions in this regard, batteries that are not backed up by conventional power plants must have much higher buffer capacity than batteries in other continental European countries – and are often even 40% oversized. A consequence of this is that it therefore often only makes economic sense to operate large battery facilities in a pool with other thermal/conventional power plants or large power plants.

### Primary control capacity

The most economically attractive source of income for large battery storage facilities is the provision of primary control capacity. On the primary reserve capacity market, energy producers receive income to quickly increase or decrease the output of their power plants by a few percent and thus balance supply and demand for electricity. Batteries can do this not only with significantly lower CO<sub>2</sub> emissions [24], but also more rapidly and more accurately. Since the commissioning of the first commercial battery storage facility in Schwerin, provision of primary reserve capacity has been the main source of income for all of the almost 180 MW of large battery storage facilities in Germany (see Figure 3.3.3.2.2).

In primary frequency regulation, frequency deviations are corrected within the millisecond to the minute range. In contrast to conventional power plants, control is provided automatically by energy storage facilities and is based on the decentralised measure-

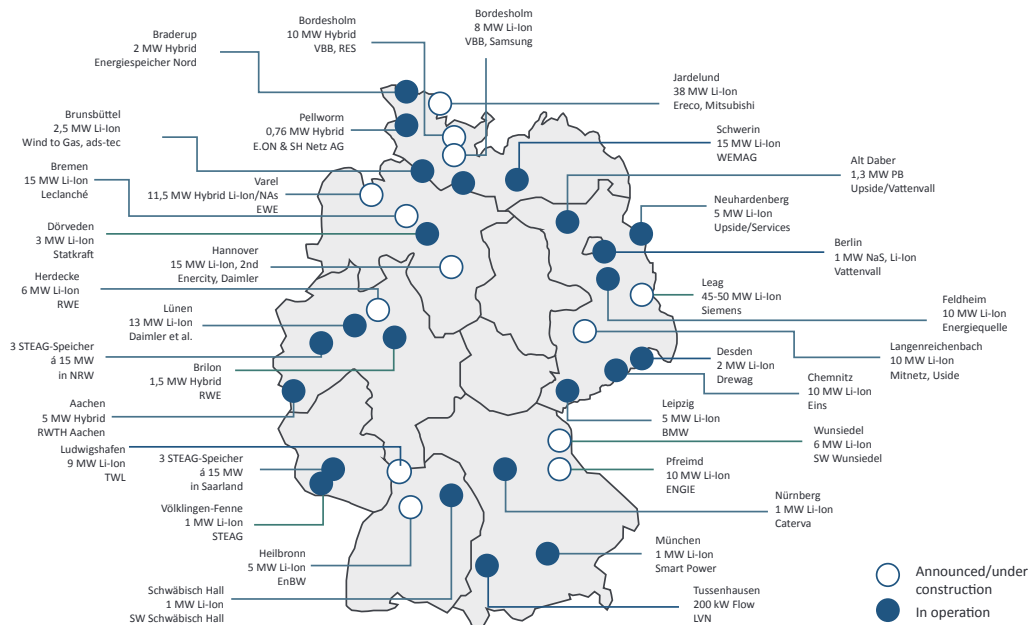


Figure 3.3.3.2.2: Large-scale battery storage facilities in Germany. | Source: Younicos. | Graphic: RENAC.

ments of grid frequency. If there is excess power in the grid – for example, because a gust of wind increases the output of wind turbines – the grid frequency rises. The energy storage system senses this ‘heartbeat’ of the grid and corrects it, fully automatically, by consuming electricity within milliseconds – until the frequency again reaches exactly 50 Hz. If the grid frequency drops – for example because a cloud shades photovoltaic (PV) arrays or because electricity consumption on the grid increases – the energy storage system reacts in exactly the opposite way and injects power into the grid.

### Other grid services

The market for primary control power is changing rapidly – not least because many new players are entering the market and battery prices are continuously declining. Therefore, also, it is important to use batteries as diversely as possible; they can provide a multitude of important system services, in some cases even providing these services simultaneously (in parallel).

Large battery storage facilities are increasingly being used in many countries in ‘multi-use-applications’ for so-called ‘revenue stacking’ (acquiring revenue streams from a battery facility via the provision of different services). However, this is happening comparatively little in Germany. In the future it will also be important for energy storage facilities to be able to react automatically to market and price signals, and then, depending on requirements, provide extra power during peak-load times, and other important grid services. Energy storage could also become an alternative to more

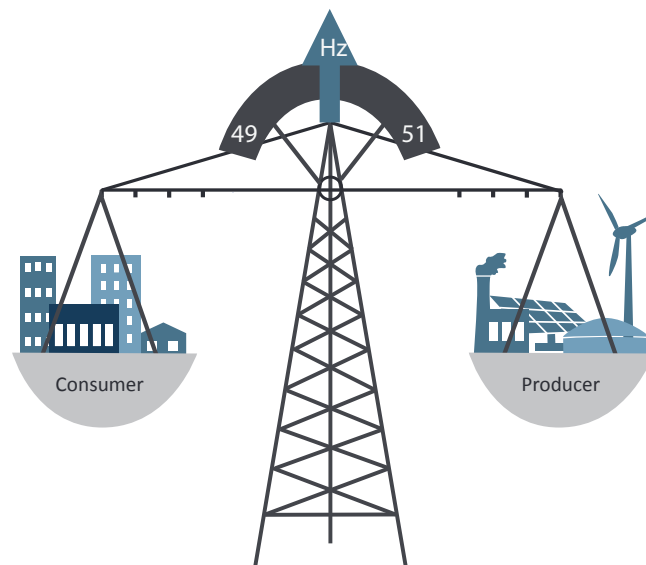


Figure: 3.3.3.2.3: In the ‘balancing energy’ market, power production and power consumption are balanced/matched to ensure a secure and stable electricity supply. | Graphic: RENAC.

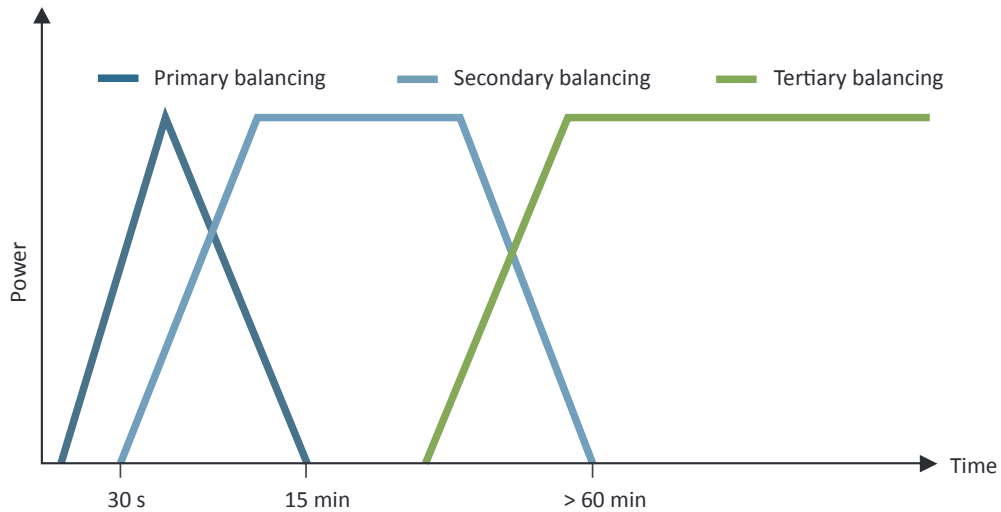


Figure 3.3.3.2.4: Structure of the market for primary reserve capacity: suppliers are required to supply positive or negative reserve capacity within 30 seconds and supply it for a maximum of 15 minutes; positive control power refers to increasing power output, negative control power refers to reducing power output. | Source: Younicos. | Graphic: RENAC.

expensive conventional expansion of the grid and make the overall grid more efficient. Expenditures for transformers, underground cables or power lines could be postponed or no longer be required. In many countries, such as in England and in the USA, energy storage facilities are used in particular to reinforce power grids and to improve power system resilience. Instead of conventional grid expansion, energy storage facilities placed strategically at grid congestion points can absorb and provide electricity during production or load peaks. However, in Germany, due to the unclear role of grid operators with regard to accessing energy storage services, and due to discrimination against third-party models in incentive mechanisms / regulations, energy storage facilities in the grid services sector are not yet used for this purpose.

### Which technology?

It is not necessary to store energy for very long periods of time in order to significantly increase the proportion of green electricity on the power grid. Numerous simulations show that even with an energy storage capacity of four hours, the annual share of renewables in electricity production, in Germany, could be increased to 60% of total electricity production, because, contrary to what one might expect, it is not that much of a problem that the sun doesn't shine at night and that sometimes it is not windy. Both solar irradiation and windspeeds are easily forecastable – and shortfalls can be offset by flexible conventional electricity generation. The real challenges are sudden gusts of high



wind at wind farms, and clouds that briefly shade large PV arrays. With batteries and intelligent software, such fluctuations can be compensated for quickly and precisely – without a conventional thermal generator always having to be run alongside. Intelligent control power and energy management systems can make existing networks ‘smart’ and decentralised. Diesel, or other fossil-fuel generators, can also be operated alongside them without being solely responsible for system stability.

There are many battery technologies available today, but lithium-ion batteries dominate the rapidly growing global energy storage market. It’s a fool’s errand to predict just how much the market for global energy storage will grow, but all reports agree that growth will increase significantly in the period 2017 – 2022. Lithium-ion batteries have almost completely replaced the previously widely used lead-acid technology – typically also used as the starter battery for internal combustion engines. Lithium-ion technology is technically superior to lead-acid, and it has fallen drastically in price in recent years due to the massive build-up of manufacturing capacities for lithium-ion electric vehicle batteries. Lithium-ion batteries last much longer than lead-acid batteries and have a much greater utilisable depth of discharge (DOD) range. At the same time, battery demand in the automotive industry is changing the dynamics of the energy storage industry. An average Tesla vehicle has an 80 – 100 kWh battery – and the 50-odd different models that German carmakers are developing for the market indicate that battery capacities will increase yet further; 100 kWh is 10 times the capacity of the average battery needed in a typical household energy storage system to make a large family home around 70% energy self-sufficient if used in conjunction with a PV system. The automotive industry already consumes more lithium-ion batteries (in terms of energy storage capacity) than any other industry. Researchers even expect the market for electric vehicle batteries and stationary energy storage batteries to be worth more in 2018 than the entire current consumer electronics battery market [25].

This megatrend is having a significant impact on the energy storage industry (stationary applications). Above all, other technologies have to compete with the enormous price pressure created by the exponential growth in the production of lithium-ion batteries. This has two, partly contradictory, effects. Low lithium-ion battery prices quickly create markets for other battery-dependent technologies while, at the same time, the grid services sector is increasingly exploiting the technological advantages of stationary energy storage in general. And, simultaneously, disruptively low-priced lithium-ion electric vehicle batteries makes it unattractive/difficult, from an economic point of view, for manufacturers to invest in producing scaled-up larger batteries specially designed for stationary applications.

Currently, the two most important alternatives to lithium-ion batteries are:

- Sodium-sulphur (NaS) batteries – These large high-temperature batteries (minimum size 0.5 MW / 3 MWh +) are a tried and tested technology and some facilities with several MW have been in operation for almost 20 years. They have high C-rates (the C-rate of a battery is a measure of the rate at which a battery is/can be charged or discharged in relationship to its energy storage capacity). They can be charged in 6 to 8 hours (C-rate of 1/6 - 1/8) and store relatively large amounts of energy quickly.
- Redox flow (RF) batteries – This type of battery exists in a number of chemical configurations; the basic principle is always that the positive and negative electrolytes are lodged in separate tanks, which theoretically allows easy scaling to high energy storage capacities, simply by using larger tanks. They typically have low C-rates (low charge and discharge rates). Interest in redox flow batteries remains high, and there are about half a dozen promising developers worldwide, though the technology is still struggling with ‘teething troubles’.

Both NaS and RF batteries are being pushed out of the (mass) market by lithium-ion because lithium-ion is already, in some cases, lower in price per kWh of storage capacity.



Figure 3.3.3.2.5: Interior view of the first commercial battery power station in Germany. The 5 MW lithium-ion facility has the equivalent reserve capacity potential of a conventional 50 MW turbine. | Source: WEMAG.

The dominance of lithium-ion for electric vehicle batteries has two important implications. Firstly, there is a tendency to produce batteries with relatively high C-rates (automakers want both high capacities and short recharging times). Secondly, the automotive industry is planning that batteries be replaced after seven years; and, as a result, there is little incentive to produce batteries that will last longer than seven years.

## Software

However, a number of measures can significantly prolong the service life of batteries. Alongside additional protection against heat and cold through correct temperature control, using the right battery management system software is particularly important. With appropriate software, even electric vehicle batteries can easily achieve a service life of 15 years or more. In addition, the right software ensures that batteries can be used to their full potential. From a purely technical point of view, it is not that important which type of battery is used for reserve capacity energy storage. With the right system, all the components of the system work well together. However, as regards the economics of battery storage, it is of great importance which technology is used and from which manufacturer is sourced. Put simply: a battery that lasts four times longer can cost twice as much as one that does not last that long; but conversely, a battery that is unusable after a few years is not profitable, even if it is almost free.

Particularly important from the economic point of view is the actual interconnection/integration of the DC batteries with the standard AC power grid. Battery suppliers require many years of experience in dealing with the cell chemistry of the batteries involved, and with optimising the battery management systems (BMS) supplied with the batteries/battery packs via alternating current battery management (ACBM) and higher-level energy management systems (EMS).

Smart or intelligent control and energy management software operates on top of manufacturers' BMS software and adds many additional important functionalities to it. This software ensures that a battery not only always does what it is supposed to do (e.g. charge and discharge in order to keep the frequency stable), but also that it is fully charged and/or chargeable so that it can be used at any time to provide any service required for as long as possible. Ideally, a battery should always be available for the different applications required of it. This is a prerequisite for making the power grid so intelligent or smart that battery storage facilities can be automatically and optimally incorporated. Unfortunately, potential users of large battery storage facilities often focus

on the wrong issues: they are primarily looking for a technology and a manufacturer; and don't think much about how the battery storage facility can best be connected to the grid and operated. Because battery storage facilities are still comparatively expensive, it is important that each facility is operated optimally for the range of respective applications required of it. Generally, the BMS supplied with a battery usually form a good basis for this, but are not sufficient on their own.

### 3.3.4 Chemical energy storage

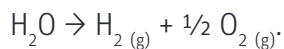
#### 3.3.4.1 Hydrogen and electrolysis

*Ulrich R. Fischer*

Due to the rapid growth of generation from renewable energy sources, the long-term energy storage requirements for electrical energy in Germany needs to be increased from around 2020 – 2025 onwards to reach a capacity of 10 to 40 TWh by 2050. Energy storage on this scale can only be realised with the use of chemical energy carriers such as hydrogen or synthetic methane. The current capacity of pumped-storage hydropower plants, presently the largest storage facilities in Germany, is only about 0.04 TWh.

#### Hydrogen production via electrolysis

The production of hydrogen via electrolysis is an important option for converting excess renewable energy into storable chemical energy. The operating principle of splitting water molecules into hydrogen and oxygen using electrical energy is described by the following general chemical formula:



There are three main methods of water electrolysis. These differ essentially in the electrolyte used and the associated temperature ranges. Table 3.3.4.1.1 lists the important characteristics of each. The alkaline electrolysis (AEL) process, which has been used for the longest time commercially, uses dilute potassium hydroxide solution as the electrolyte and takes place at temperatures of up to approximately 80°C. The largest plant of this type was built as early as 1965 – 1970 at the Aswan dam in Egypt; it had an electrical power rating of 160 MW and could produce hydrogen at the rate of about 32,000 Nm<sup>3</sup>/h.

Proton-exchange membrane electrolysis (PEMEL) uses a proton-conductive membrane which simultaneously acts as the electrolyte. In recent years, some manufacturers have

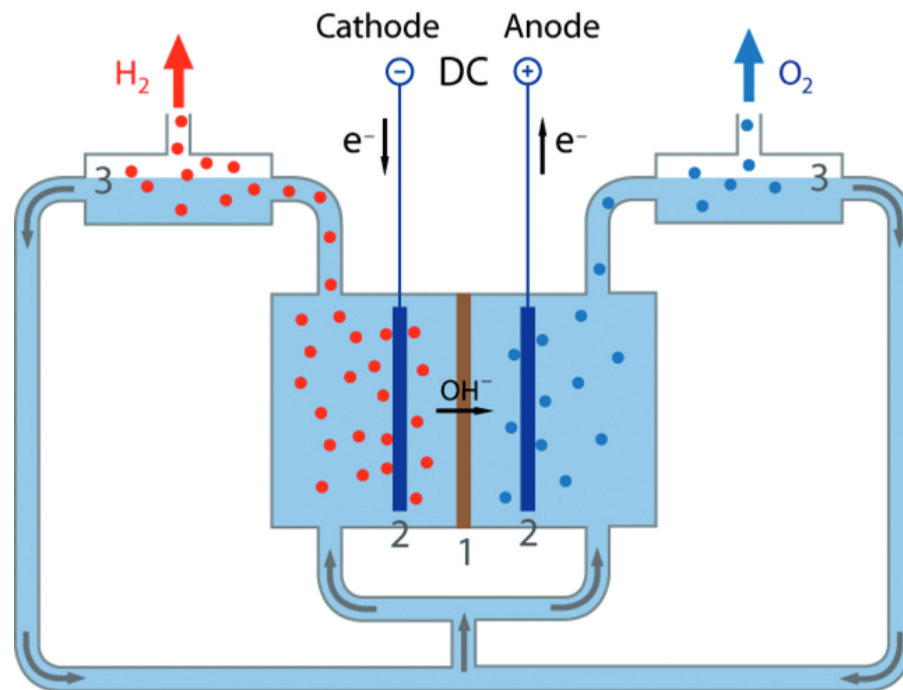


Figure 3.3.4.1.1: Operating principle of an alkaline electrolysis cell. | Source: Dr. U.R. Fischer.

been offering systems in the power range of above 1 MW (with hydrogen production rates of about 200 Nm<sup>3</sup>/h). PEMEL has the advantages of higher power density, better dynamic characteristics and overload capacity; but these advantages are currently offset by its higher rate of efficiency degradation and the use of expensive precious metal catalysts. Intensive research is currently being carried out into PEMEL technology with the aim of reducing its cost and increasing the size of plants. High-temperature electrolysis (solid oxide electrolysis or SOEL), or steam electrolysis, uses a ceramic solid electrolyte which becomes conductive for oxygen ions at very high temperatures. In recent years, this technology has moved from the research phase to the first commercial applications in the low power range, with hydrogen production rates up to about 50 Nm<sup>3</sup>/h. Thermodynamically, high temperature electrolysis has the advantage that some of the energy required for splitting the water molecules can be supplied by heat energy (e.g. waste heat from other industrial processes) instead of by expensive electrical energy. Because of this, SOEL offers energy advantages for plants which also convert the hydrogen produced into methane, exploiting the otherwise wasted heat of the methanation process.

The principle of water electrolysis, using the AEL process as an example, is shown in Figure 3.3.4.1.1. Two metallic electrodes (2), e.g. of nickel, are immersed in a good

	AEL	PEMEL	SOEL
Temperature range	60 – 80°C	50 – 80°C	700 – 1,000°C
Electrolyte	Potassium hydroxide	Proton-exchange membrane e.g. Nafion®	Solid oxide, e.g. YSZ – yttria-stabilised zirconia
Charge carrier in the electrolyte	OH <sup>-</sup>	H <sup>+</sup>	O <sup>2-</sup>
Chemical reaction anode	2OH <sup>-</sup> → ½ O <sub>2</sub> + H <sub>2</sub> O + 2e <sup>-</sup>	H <sub>2</sub> O → ½ O <sub>2</sub> + 2H <sup>+</sup> + 2e <sup>-</sup>	O <sup>2-</sup> → ½ O <sub>2</sub> + 2 e <sup>-</sup>
Chemical reaction cathode	2H <sub>2</sub> O + 2e <sup>-</sup> → H <sub>2</sub> + 2OH <sup>-</sup>	2H <sup>+</sup> + 2e <sup>-</sup> → H <sub>2</sub>	H <sub>2</sub> O + 2 e <sup>-</sup> → H <sub>2</sub> + O <sup>2-</sup>
Development stage	Commercially available	Commercially available	Commercially available
Typical hydrogen production per stack	≤ 1,000 Nm <sup>3</sup> /h	≤ 500 Nm <sup>3</sup> /h	≤ 50 Nm <sup>3</sup> /h

Table. 3.3.4.1.1: Types of electrolysis and their characteristics.

electrically-conductive electrolyte solution (potassium hydroxide solution / KOH). When a DC voltage is applied, the electrolytic splitting of the water molecules is initiated. Hydrogen is produced at the cathode and oxygen at the anode. The membrane (1) is permeable only to hydroxide ions and prevents the mixing of hydrogen and oxygen in the electrolysis cell – a hydrogen and oxygen mixture is an explosive gas. The gas bubbles (O<sub>2</sub> and H<sub>2</sub>) are transported via the electrolyte circuit to the separators [3], where they are separated from the potassium hydroxide solution. Typical decomposition voltages (voltage at which the water splits into hydrogen and oxygen molecules) for a single alkaline electrolysis cell are in the range of about 1.8 to 2.2 V. To increase hydrogen output, single cells are electrically connected in series to form a cell stack. The water supply required is not shown in the diagram. Figure 3.3.4.1.2 shows the operating principle of a PEM electrolysis cell. The catalyst-coated electrodes are connected directly to the proton-conductive membrane to form the membrane-electrode assembly, which is connected via current conductors directly to the bipolar plates. The discharge of the gases produced takes place via the channels in the bipolar plates and the water is supplied on the anode side.

In practical applications, the hydrogen must be produced at high pressure. This can be achieved using a downstream compressor, but an alternative is direct electrochemical compression. The latter can be advantageous in terms of energy efficiency and from the technical point of view. The cells / cell stack and other components need to be pressure-tight because the formation of the product gases leads to a pressure build-up. Typical commercially available pressure electrolyzers range up to about 40 bar, although

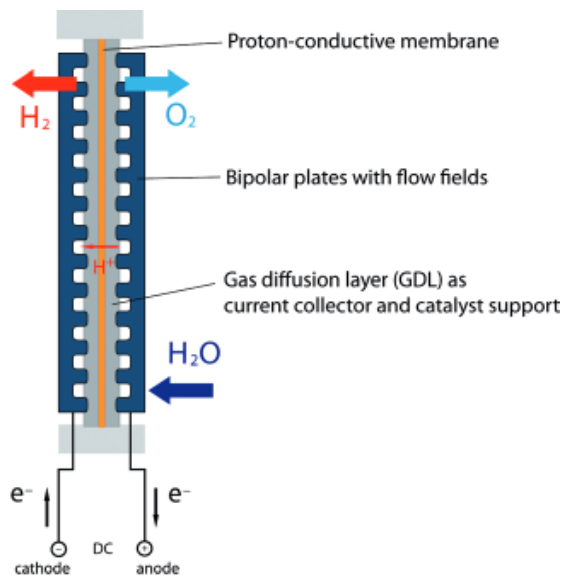


Figure 3.3.4.1.2: Operating principle of a PEM electrolysis cell. | Source: Dr. U.R. Fischer.

pressures higher than 100 bar have been achieved in the laboratory, especially with the more compact of PEM electrolysis cell stacks. Figure 3.3.4.1.3 shows an alkaline pressure electrolyser with an external pressure vessel for the cell stack; it uses direct electrochemical compression and reaches a pressure of 60 bar.

### Efficiencies and other parameters

The efficiency of the electrolysis process is defined as the ratio of the energy content of the hydrogen produced to the electrical energy used in the process. Different efficiency values are arrived at depending on which calorific value of hydrogen one uses – its ‘gross calorific value’ or ‘higher heating value’ (HHV = 3.54 kWh/Nm<sup>3</sup>), or its ‘net calorific value’ or ‘lower heating value’ (LHV = 3.00 kWh/Nm<sup>3</sup>). Typical values for the ‘higher heating value’ efficiency HHV of modern alkaline electrolysers are 79 – 90%. To avoid confusion when defining the efficiency of a cell, often only the electrical energy consumption required to produce a ‘normal cubic meter’ of hydrogen is used (kWh/Nm<sup>3</sup>). Theoretically, for the production of one kilogram of hydrogen, nine litres of water are consumed. This corresponds to 0.81 litres per ‘normal cubic meter’ (Nm<sup>3</sup>) of hydrogen. In practice, water consumption is about 5 – 10% higher.

Other important and desirable electrolyser properties are low partial and high overload capacity, fast reactivity to changes in the electrical input power, and low power self-consumption in standby mode. These requirements are particularly important when the power supply to the electrolysers is from intermittent renewable energy sources.

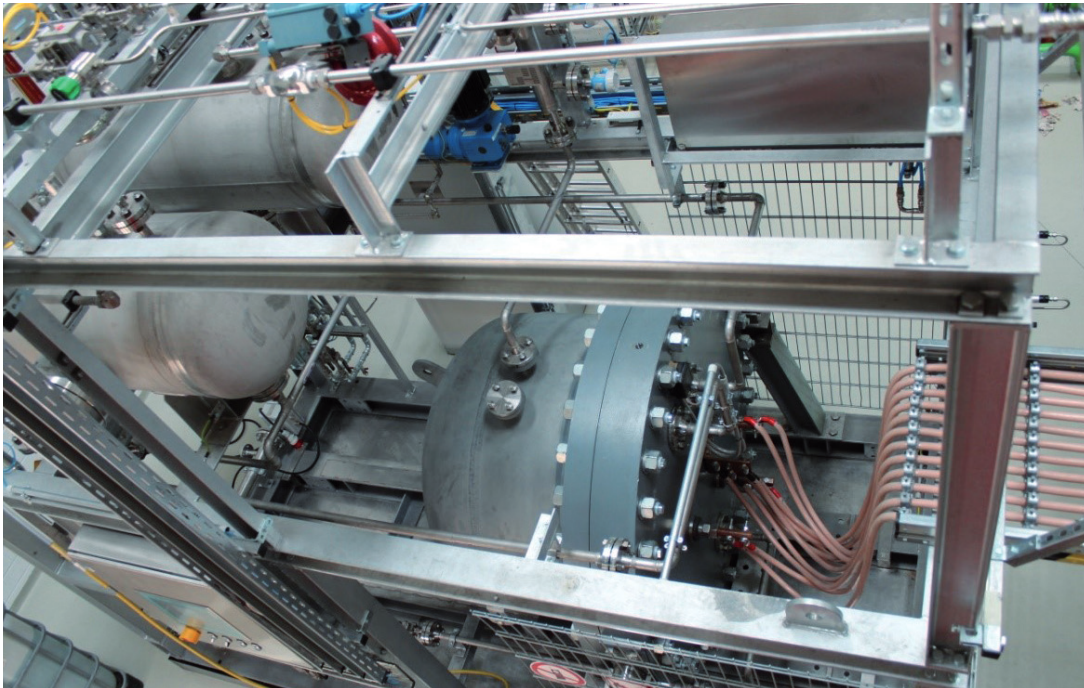


Figure 3.3.4.1.3: A 60-bar pressure electrolyser at the Hydrogen Research Centre of the Brandenburg Technical University Cottbus-Senftenberg, Germany. | Source: Brandenburgischen Technischen Universität Cottbus-Senftenberg.

### Applications and future prospects

The conversion of surplus renewable energy into hydrogen (power-to-hydrogen) is a technology that can be used in many situations. In one of the first demonstration projects, the ENERTRAG AG hybrid-power plant in Prenzlau, Germany, a wind farm has been directly coupled with an alkaline electrolyser. The hydrogen produced can be fed, when required, together with biogas from a connected biogas plant, into a mixed-gas CHP plant. Further options include direct delivery to hydrogen filling stations in Berlin or feeding it into a natural gas pipeline.

In the medium term, power-to-hydrogen technology can prevent congestion on the electric power grid, especially on the distribution network. Further ahead, underground hydrogen storage in caverns and reconversion into electricity opens up the possibility of a long-term energy storage on the TWh scale; storage on this scale will be absolutely necessary if renewable energy in Germany is to be extensively expanded.



### 3.3.4.2 Methanation

*Michel Kneller*

Methanation is a technology for producing methane from hydrogen and carbon monoxide (CO) or carbon dioxide (CO<sub>2</sub>) and is considered to be a very promising method of storing energy generated from renewables. The hydrogen required by the process is produced by electrolysis. The energy required for this can come from excess power produced by wind or solar (see Chapter 3.3.4.1). The CO/CO<sub>2</sub> required can come from conventional fossil-fuel power plants, coal gasification, the chemical industry or – to produce a synthetic ‘natural gas’ from purely renewable energy sources – from biomass gasification.

#### Conditioning

CO<sub>2</sub> obtained from power stations flue gas is about 10 to 18% of the volume of flue gas. Various methods can be used to separate (extract) the CO<sub>2</sub> from the flue gas. However, these methods are associated with high costs and high energy requirements. They can lead to a reduction in overall power plant efficiency of about 10% because the flue gas must be purified by removing sulphur- or chlorine-containing compounds that act as catalyst poisons. It is in most cases then necessary to compress the flue gas to system pressure before the CO<sub>2</sub> content can be reduced in a washing process or a CO-conversion process. This washing process can take place either upstream or downstream of the methanation process and serves to increase the calorific value / Wobbe Index of the synthetic natural gas produced. The washing process is carried out at high pressures and low temperatures (cooled to 35°C. at least).

#### Methanation

Methanation involves a catalytic reaction of hydrogen with carbon monoxide / carbon dioxide. The end products are methane and water. In addition to the actual methanation reaction (dry methanation), there are further parallel reactions. The reaction conditions should achieve the following:

- a large CH<sub>4</sub> methane yield
- a high CO conversion (low CO residual content)
- a high H<sub>2</sub> conversion (low H<sub>2</sub> residual content).

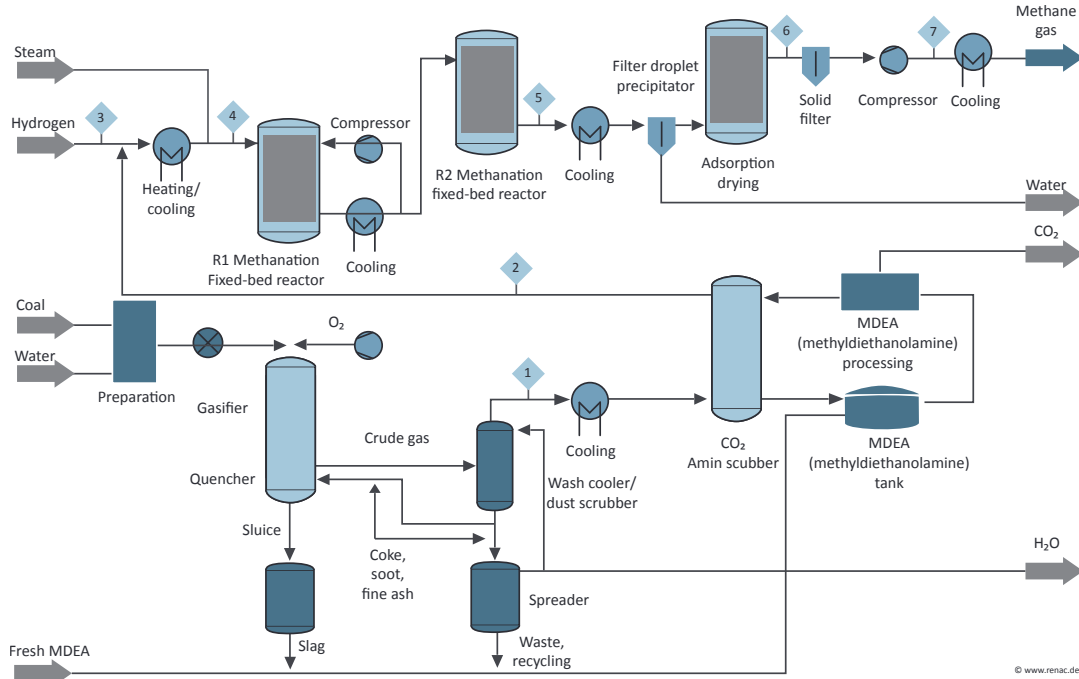


Figure 3.3.4.2.1: Methanation – process diagram. | Source: ILF | Graphic: RENAC.

For the highest methane yield, a stoichiometric ratio of H<sub>2</sub> to CO of 3:1, combined with a high operating pressure, is ideal; the reaction equilibrium is favoured by the reaction to methane at high pressures.

The chemical formula which describes the process is:



If the stoichiometric ratio of H<sub>2</sub> to CO decreases to 1:1, the methane yield also decreases because the direct conversion of CO<sub>2</sub> to methane in the methanation process slows down due to the thermodynamic stability (chemical inertness) of CO<sub>2</sub>. Therefore, a high H<sub>2</sub> to CO ratio should be used in the process. An undesirable side reaction in methanation is carbonisation (coking) of the catalysts caused by carbon deposits. However, the addition of water vapour to the process can reduce this coking by suppressing the formation of carbon and increasing the production of CO.

The avoidance of high temperatures and ‘hotspots’ in the reactor during methanation is important, otherwise the methane produced will be ‘re-formed’ (its molecular structure

will be rearranged). Because the chemical reactions are exothermic, either an intermediate cooling system or a reactor with good heat removal is necessary. This heat can be captured and used elsewhere in the process.

## Processing

Following methanation, the resultant synthetic natural gas is cooled to about 35°C, and incidental condensate removed via a filter. Subsequently, via adsorption drying, the ‘dew point’ of the synthetic natural gas is brought to that required by natural gas network. Depending on the composition of the gas, the CO<sub>2</sub> concentration must be reduced with an adsorption scrubber in order to comply with the gas specification required. A compressor compresses the gas to natural gas network pressure. A cooler then lowers the gas temperature to 35°C before it is fed into the natural gas network.

## Possibilities of interlinking various energy sectors

Methanation is one of the technologies for the production of synthetic fuels, so-called ‘e-fuels’. These e-fuels can be used in internal combustion engines, just like gasoline or diesel. Thus, for example, ships, aircraft, trucks or cars could be powered almost CO<sub>2</sub> neutral. The process chains used to generate e-fuels from electric power are referred to as ‘power to gas’ (P2G or PtG), ‘power to liquid’ (P2L or PtL), or as ‘power to x’ (where the x in P2X or PtX can refer to a range of energy carriers).

The efficiency of a power-to-gas or a power-to-liquid process that produces synthetic fuels for the transport sector is currently around 50%. These processes are still in the development phase, and an increase to around 70% is considered possible. The investment costs of these processes are approximately 1,000 – 4,000 € per kW [32]. However, it is expected that these will decrease significantly over time because of technological advances, increasing plant sizes and volumes [26] – [32].

### 3.3.5 Underground gas storage

*Jens Kottsieper, Hans Neumeister*

There is a large number of underground storage facilities for natural gas and crude oil around the world. The total available storage volume for natural gas is more than 430 billion standard cubic meters. These storage facilities are used primarily in central Europe to compensate for short-term and seasonal variations in gas demand (summer-winter

difference due to heating demand, differences in electricity demand due to lighter and darker seasons, workdays and non-work days); but they also serve as a strategic reserve (providing security of supply) and as a buffer against fluctuating gas prices.

Demand for underground storage was long considered sufficiently met in central Europe, but the increase in the use of renewable energy and the transition to a sustainable energy system could increase demand further. At present, however, the basic idea is to optimise the use of existing facilities and infrastructure (see also Chapter 3.2.2 Gas networks). Existing storage facilities for hydrocarbons could be retrofitted to store energy carriers produced by renewable energy sources, or new storage facilities, could store the following:

- Air or compressed air (see Chapter 3.3.1.3 Compressed air energy storage)
- Hydrogen (compare also Chapter 3.3.4.1 Hydrogen and electrolysis)
- Synthetic natural gas (see also Chapter 3.3.4.2 Methanation)
- Carbon dioxide (for intermediate storage for methanation of hydrogen, or carbon sequestration).

Basically, underground gas storage systems can be classified into two types, mainly according to how they differ with regard to gas injection and gas extraction rates. In addition, the extraction capacity depends on the design of the processing equipment that guarantees the quality of the gas for sale:

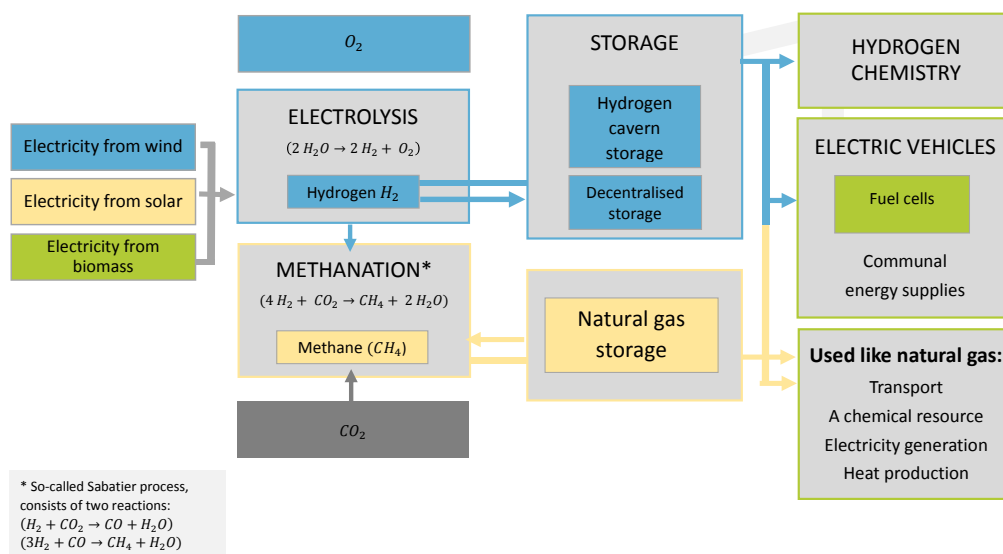


Figure 3.3.5.1: The hydrogen added value chain. | Source: HYPOS.

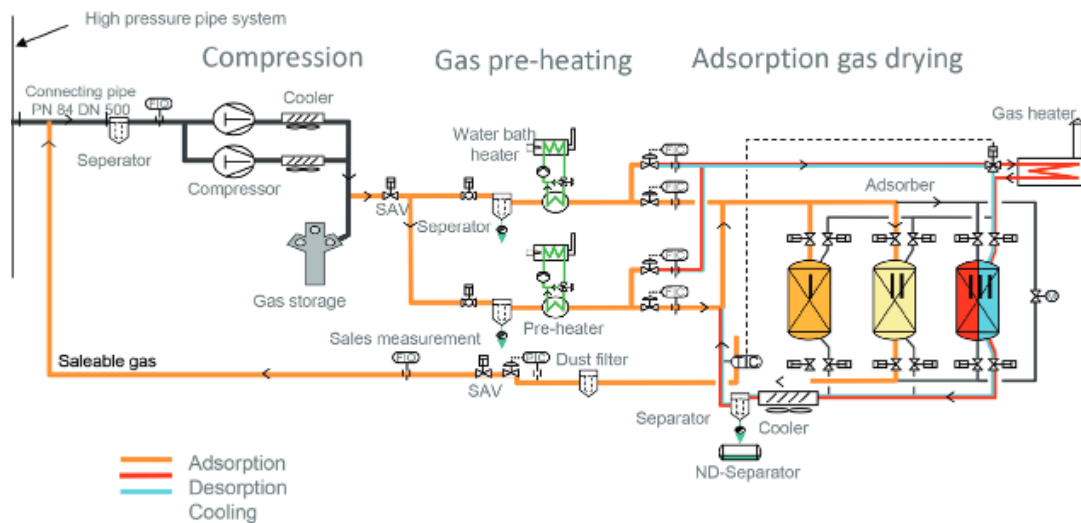


Figure 3.3.5.2: Gas storage technology – this example is from a facility near the Lesum river, Germany. | Source: ILF.

- Salt cavern energy storage facilities are usually characterised by high injection and extraction rate capacities due to the architecture of the caverns. Also, maximum gas extraction is limited to the removal of water vapour.
- Pore energy storage facilities (porous rock storage) are usually depleted natural gas reservoirs. The gas storage takes place in the porous rock and offers, in comparison to the salt cavern energy storage, a larger storage volume. However, achievable injection and extraction rates are lower compared to salt cavern storage. The necessary processing of the gas during extraction depends to a large degree on the geological characteristics of the reservoir rock and often requires the separation of higher hydrocarbons and sulphur compounds in addition to the separation of water vapour.

Higher injection and extraction rates are often preferred because they increase the economic viability of energy storage. It is to be expected, due to the intermittency and peaks associated with the generation of electricity from renewable energy, that demands on injection rates, extraction rates and storage-medium turnover will be high. Venting or flaring of excess gas because there is a lack of storage capacity would be counterproductive and inefficient with regard to the expense of producing the gas in the first place. Cavern storage systems can also be used as redox flow batteries (see Chapter 3.3.3.2 Batteries for system stability); however, this requires cavity sizes of

between 300,000 and 600,000 m<sup>3</sup>. Pore storage facilities are not suitable for this application.

Figure 3.3.5.2 shows a typical cavern gas-storage facility; the example is from a facility near the Lesum river, Germany. Currently, there are no underground storage facilities for pure hydrogen in commercial use. There are, however, some pilot projects. In particular, research is being conducted into the level of potential hydrogen diffusion losses with long-term storage, since losses reduce profitability. When storing synthetic natural gas, i.e. methanised hydrogen, this problem does not exist.

Storage plays an important role in the hydrogen value-creation chain (see Figure 3.3.5.1). Energy from a renewable source is converted into hydrogen via electrolysis and is then stored in hydrogen-storage caverns. If the hydrogen has been methanised, the resulting synthetic natural gas can be stored in a natural gas storage facility. The hydrogen can be used as a chemical resource, or distributed the way natural gas is distributed, and subsequently used in fuel cells in the transport or heating sector. Synthetic natural gas (syngas) can be used exactly like natural gas [33] – [34].

## References

- /1/ G. Fuchs, B. Lutz, et al., *Technologischer Überblick zur Speicherung von Elektrizität: Überblick zum Potenzial und zu Perspektiven des Einsatzes elektrischer Speichertechnologien; Im Auftrag der Smart Energy for Europe Platform GmbH (SEFEP)*, Berlin, September 2012.
- /2/ *Renewables 2017: Global Status Report*, REN21, Montreal, QC, CA, 2017.
- /3/ DOE Global Energy Storage Database, [www.energystorageexchange.org](http://www.energystorageexchange.org).
- /4/ M. Kaltschmitt, W. Streicher, A. Wiese, *Erneuerbare Energien: Systemtechnik, Wirtschaftlichkeit, Umweltaspekte*, Springer Vieweg, Berlin, 2013.
- /5/ *Von Kohlehalden und Wasserstoff: Energiespeicher – zentrale Elemente der Energieversorgung*, Frankfurt am Main, Oktober 2013.
- /6/ N. Hartmann, L. Eltrop, et al., *Stromspeicherpotenziale für Deutschland*, Stuttgart, Juli 2012.
- /7/ J. Giesecke, S. Heimerl, *Wasserkraftanlagen*, Springer Berlin Heidelberg, Berlin 2014.
- /8/ B. Janzing, *Kraft auf Vorrat*, neue energie (07/2010) 24–31.
- /9/ *Der Beitrag von Pumpspeicherwerken zur Netzstabilität und zur Versorgungssicherheit – die wachsende Bedeutung von Pumpspeicherwerken für die Energiewende*, Berlin, 16.07.2015.
- /10/ P. Stenzel, R. Bongartz, et al., *Energiespeicher*, BWK - Das Energie-Fachmagazin 66 (2014) 42–55.
- /11/ *Potenziale der Wärmepumpe zum Lastmanagement im Strommarkt und zur Netzintegration erneuerbarer Energien*, 31. Oktober 2011.

- /12/ Der Powertower, Entwicklung eines hydraulischen Energiespeichers, V. Neisch, B. Brinkmeier und M. Aufleger; Wasserbausymposium 2012 Graz, Wasser Energie, Global denken – lokal handeln, Graz, Austria.
- /13/ [www.heindl-energy.com/de/der-lageenergiespeicher/idee-funktion.html](http://www.heindl-energy.com/de/der-lageenergiespeicher/idee-funktion.html)
- /14/ [www.gravitypower.net/](http://www.gravitypower.net/)
- /15/ [www.powertower.eu/](http://www.powertower.eu/)
- /16/ [www.buoyant-energy.com/](http://www.buoyant-energy.com/)
- /17/ *Electricity Storage Gaining Momentum*, Benoit Decourt, Romain Debarre, Sylvain Alias and Prashant Gahlot, AT Kearney Energy Transition Institute, 2018.
- /18/ *Identifying and Overcoming Critical Barriers to Widespread Second Use of Plug-in Electric Vehicle (PEV) Batteries*, National Renewable Energy Laboratory – NREL, J. Neubauer, K. Smith, E. Wood, and A. Pesaran, February 2015.
- /19/ Bundesverband Erneuerbare Energien - BEE, Hannover Messe, Gerard Reid and Javier Julve, April 2016, Second Life Batterien als flexible Speicher für Erneuerbare Energien.
- /20/ Focus Online, März 2018: Stromversorger nutzt ausgediente E-Auto-Batterie
- /21/ Forschungsstelle für Energiewirtschaft – fE, Technische Universität München – TUM (Sebastian Fischhaber, Anika Regett, Simon F. Schuster, Dr. Holger Hesse), Februar 2016: Second-Life-Konzepte für Lithium-Ionen-Batterien aus Elektrofahrzeugen.
- /22/ [https://www.energy-storage.news/blogs/digital-inertia-energy-storage-can-stabilise-grid-with-1-10-the-capacity-of?utm\\_source=rss-feeds&utm\\_medium=rss&utm\\_campaign=general](https://www.energy-storage.news/blogs/digital-inertia-energy-storage-can-stabilise-grid-with-1-10-the-capacity-of?utm_source=rss-feeds&utm_medium=rss&utm_campaign=general)
- /23/ <http://www.dena.de/projekte/energiesysteme/dena-studie-systemdienstleistungen-2030.html>
- /24/ [http://www.fz-juelich.de/SharedDocs/Downloads/IEK/IEK-STE/DE/Publikationen/preprints/2015/preprint\\_03\\_2015.pdf?\\_\\_blob=publicationFile](http://www.fz-juelich.de/SharedDocs/Downloads/IEK/IEK-STE/DE/Publikationen/preprints/2015/preprint_03_2015.pdf?__blob=publicationFile).
- /25/ <https://insideevs.com/battery-revenues-from-transportation-ess-to-overtake-consumer-electronics-by-2018/>
- /26/ gwfGas|Erdgas Fachberichte Rohrnetz, Speicherung von regenerativ erzeugter elektrischer Energie in der Erdgasinfrastruktur, S.BajohLM.GötzF.GraFF.Ortloff, April 2011.
- /27/ Wissenschaft & Technik Nachrichten, Aus Ökostrom wird Ökogas, (te).
- /28/ Solarzeitalter IRES 2009, Erneuerbares Methan, Michael Sterner und Michael Specht, 1/2010.
- /29/ ew Fachthema Gaswirtschaft, Konvertierung von Strom in Methan: Ausbauhelfer für Ökostrom, Gregor Waldstein, Jg. 110 2011 Heft 11.
- /30/ Jan Kopyscinski T. SchildhauerS.Biollaz, *Production of synthetic natural gas (SNG) from coal and dry biomass – A technology review from 1950 to 2009*, Elsevier 2010.
- /31/ <https://www.bundestag.de/blob/544092/dab1b2ac5f0264e4b35ea370d197922e/wd-5-008-18-pdf-data.pdf>.
- /32/ <https://www.euwid-energie.de/power-to-gas-wirkungsgrad-steigt-und-kosten-sinken/>
- /33/ Strategieplattform Power to Gas, Juli 2018: HYPOS – Hydrogen Power Storage & Solutions East Germany
- /34/ <http://www.cedigaz.org/documents/2017/Overview.pdf>.

## **4 Project Setup and Implementation**

### **4.1 Organising the transition towards renewable energy**

*Adolf Feizlmayr*

#### **The objective**

In the Paris Agreement on climate protection of December 2015, the international community committed itself to limiting global warming to a maximum of a 2°C temperature rise by drastically reducing net greenhouse gas emissions. Despite the Paris Agreement to curb greenhouse gas emissions, fossil fuels still account for 81% of global primary energy production [1], which means that the average global atmospheric temperature could reach 4.5°C unless efforts to reduce net greenhouse gas emissions are significantly intensified. This makes a worldwide energy transition away from fossil fuels and towards renewable energy technologies imperative. This energy transition is an even greater challenge than digitalisation.

#### **Implementation of the transition**

Apart from saving energy by reducing energy consumption, the practical implementation of the measures summarised in the introduction requires the creativity and expertise of engineers. A systematic approach, as illustrated in Figure 4.1.1, is essential – only thus, on basis of an appropriate and balanced mix of different energy sources, can tailor-made solutions be developed and implemented. The four steps described in Figure 4.1.1 are derived from project setup and implementation experience and are explained in more detail below.

##### **1. Assessment of the status quo and definition of objectives**

An assessment (stock taking) of the status quo of the existing energy supply situation requires strong local participation, including the public, policy makers and industry. At the same time, the renewable energy potential must be assessed. This is an essential task for the energy engineering consultant. Assessing solar energy resources/potential is much simpler and costs far less than assessing wind energy resources/potential. The overarching objective is essentially that defined by the Paris Agreement. In order to define specific objectives in detail, including timeframes, and to find effective solutions, close coordination between policy makers and energy engineering consultants is required.



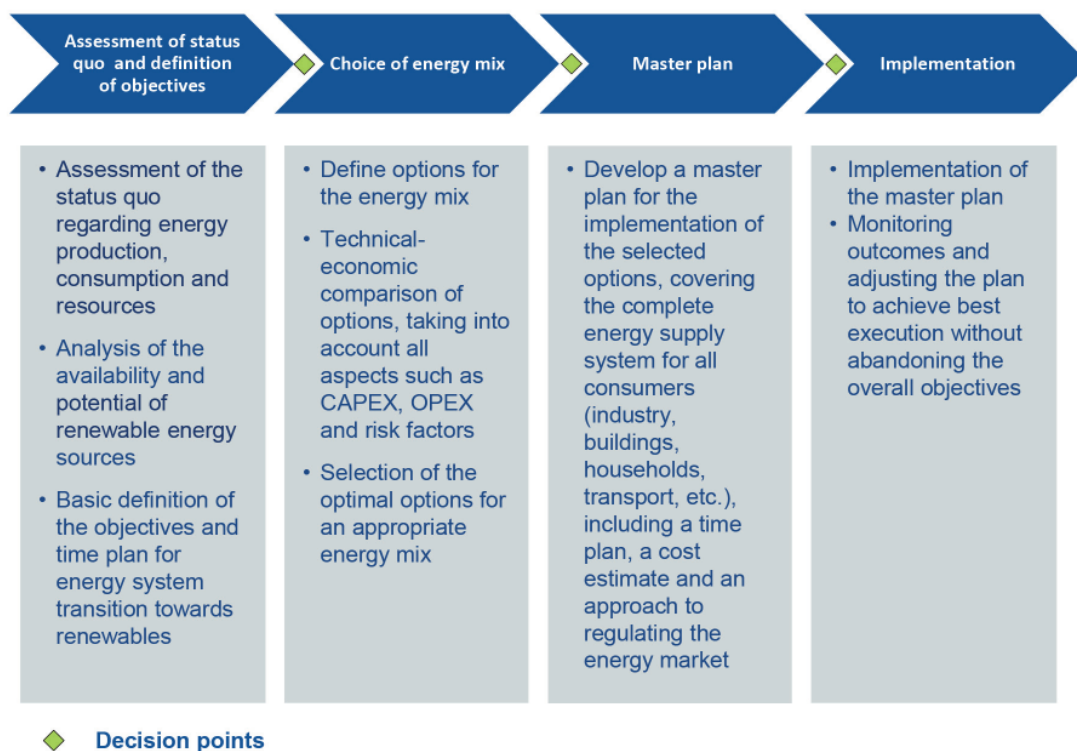


Figure 4.1.1: Methodical four-step approach to implementation of a transition towards renewables. | Source: A.H. Feizlmayr, ILF.

## 2. Choice of energy mix

In order to determine the appropriate energy mix, different possible scenarios must first be defined. Each scenario represents an energy system that includes all energy consumers (industry, buildings, households and transport), and whether the energy being consumed is thermal (heat) or electrical. Compiling detailed proposals for different alternate scenarios is a complex task because it requires the coupling/interconnection of different energy sectors. This can only be done using a holistic approach, requiring comprehensive expertise regarding how all energy technologies, both fossil fuel and renewable, function, and may be applied. It can only be done with the aid of suitable modelling software. This requires engineers from many technical disciplines. Economic, environmental, social and political criteria must also be considered in the evaluation and comparison of different scenarios.

The greatest challenge in implementing a transition to an energy system based on renewables is the selection of an optimal energy mix. The energy mix is optimal when it achieves the objectives shown in the triangle of objectives for a sustainable energy policy as illustrated in Figure 4.1.2.

The level of the expected reduction in greenhouse gas emissions, and thus the share of renewable energies in the energy mix, are key determinants of environmental compatibility. The available CO<sub>2</sub> emission reduction technologies used to ‘displace’ fossil fuels, deriving from adopting CO<sub>2</sub> emission reduction policies, have to be ranked according to their underlying cost-effectiveness in order to minimise the economic burden on the national economies.

The intermittent nature of the energy supply from renewables such as solar and wind energy is a challenge for security of supply. Fossil fuel based energy and energy storage facilities can be used to compensate for this. Ensuring security of supply creates power plant redundancies and overcapacities, resulting in the lower utilisation of the capacity of individual plants. A well-functioning energy market will reduce both technology and economic imbalances/mismatches as regards power plant load requirements.

Short-term energy storage is often already available. However, long-term energy storage facilities, such as in the form of hydrogen produced from renewables, are still rare or expensive. This is a field in which significant progress in research and development still needs to be made.

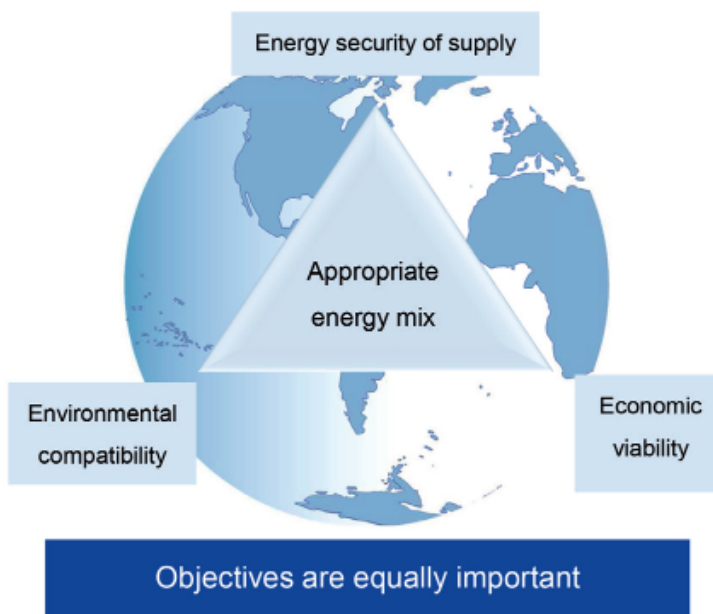


Figure 4.1.2: Triangle of objectives for a sustainable energy policy. | Source: Dr. Hans-Wilhelm Schiffer, World Energy Council.

Therefore, one of the crucial questions to be resolved when choosing an appropriate and balanced energy mix is: what percentage of renewable energy included in the energy mix is compatible with ensuring security of supply and energy affordability?

### **3. The master plan**

The measures identified as being necessary for the transition to a new energy mix should be set out in a master plan. This master plan must not only be widely supported by the political leadership of a country/region, but also widely accepted by the business community and the general public. In order to achieve this broad acceptance, it needs to be clear to the various interest groups that there is now a comprehensive plan for implementing a transition to a new energy mix/system in place, in addition to providing information as regards relevant laws, policies, guidelines and other specific issues. The master plan should be transparent, honest, comprehensible and convincing. It should be designed and presented in such a way that it attracts public attention, be effectively publicised and discussed with the public. Acceptance presupposes trust but also requires professional public relations work. It should also be shown what the consequences might be were the plan not to be implemented.

The master plan should:

- Provide the necessary planning security framework for driving forward the innovations and investments required for implementation of the plan
- Provide resilient framework conditions for local plans
- Create a clear basis for effective monitoring (comparing plan targets with actual outcomes).

### **4. Implementation**

Effective monitoring is needed to successfully manage the implementation of the master plan. The master plan and/or its objectives will also need to be updated and adapted at regular intervals.

#### **The German energy transition**

Implementing the transition from fossil fuels towards renewables in the energy supply system of a country or region is a challenging task. It is well worthwhile looking at both the positive and negative experiences made in Germany regarding its transition towards renewables.

The German energy revolution began 35 years ago with initial studies and concept evaluations. In 2002, it reached a climax with the decision of the Federal Government to phase out German nuclear power plants. In 2010, Germany adopted a concept for the transition to environmentally friendly, reliable and affordable energy. By 2018, more than 40% of net electrical energy was already being generated from renewable energy sources; and with an installed renewables capacity of more than 116 GW, renewable energy power plants exceeded the 80 GW capacity of fossil power plants [2] [3]. The overall plan is that by 2030 50% of the electrical energy should come from renewables. Germany has significantly subsidised the transition to renewables, which has led to high costs for German energy end-users. The current mass production of photovoltaic modules and wind turbines can be traced back, largely, to the innovative market signals released by promoting this transition to renewables. In recent years, the specific costs (costs per kW installed) for renewable energy systems and plants have fallen substantially – a development which makes a significant contribution to global climate protection. In some regions of the world, such as the Middle East, renewables are already competitive with fossil fuel based energy.

Thanks to the experience gained during Germany's transition to renewables, German consulting engineers are especially positioned to provide the expertise required to implement the various and complex measures described in the following chapters.

## **4.2 Engineering services**

*Andreas Wiese*

An overview of the different phases and processes in a renewable energy project is illustrated in Figure 4.2.1. There are three main phases: project development, implementation and, at the end of a project's operating life, decommissioning. The first two phases are by far the most important. The project development phase consists of a feasibility (viability/do-ability) phase and the planning and design process. Project implementation consists of the construction phase and the operational phase.

The consulting engineer provides essential services through all project phases, either alone or in conjunction with other consultants and project stakeholders. The example illustrated in Figure 4.2.1 is fairly typical for privately financed projects (see also Chapter 5.2 Project financing and related engineering services). But in principle, projects which are exclusively publicly-funded or mixed public-private partnerships (PPPs) would unfold in a similar way. All activities in which the consulting engineer has a significant or leading

function are in blue. In the feasibility (viability/do-ability) phase, the consulting engineer develops the initial project idea through to a first preliminary project concept via a pre-feasibility study. This preliminary project concept then becomes the basis for the feasibility study, which leads to a final project concept. Potential energy resource assessments and energy requirements/demand analyses can be included in the pre-feasibility or the study feasibility, but they can also be separate work packages.

Further engineering services regarding the project planning and design process are initiated only after the fundamental feasibility of the project has been demonstrated by the feasibility study. These include the engineering planning and design tasks that will serve as the basis for invitations to tender for work contracts, power plant components or the delivery of a complete 'turnkey' plant in the form of an EPC (engineering, procurement, construction) contract. Invitations to tender are followed by assessments of bids/offers received, contract negotiations and the final awarding of contracts. In projects that rely on external financing, contracts are usually awarded subject to the approval of the bank/financing institution. Normally, initiating the official approval process (for building permits, etc.) for a project begins some time after the start of the planning and design process and is eventually completed in good time before the so-called financial close (for a definition of 'financial close', see Chapter 5.2). During the project planning, project financing is also arranged, for which the engineering consultant also provides important input (cost information, yield data, risk assessments, etc.).

After financing has been arranged, a due diligence review is commissioned and carried out. Technical due diligence reviews are carried out by consulting engineers, while other specialists deal with topics such as taxes, legal issues, etc. These due diligence reviews are conducted by independent consultants employed by the bank/financing institution. If the conclusions are positive, the bank/financing institution and the equity investors can jointly decide on the financial close.

During the project construction phase, the essential tasks of the engineering consultant are carried out on the construction site in order to monitor construction work, system commissioning, but also to carry out selective inspections in the manufacturers' and suppliers' works in order to monitor the quality and specifications of equipment being installed. The monitoring of construction activities usually requires a permanent on-site presence at the construction site. Another important activity during the construction phase is reviewing and approving contractors' and/or suppliers' designs and workplans.

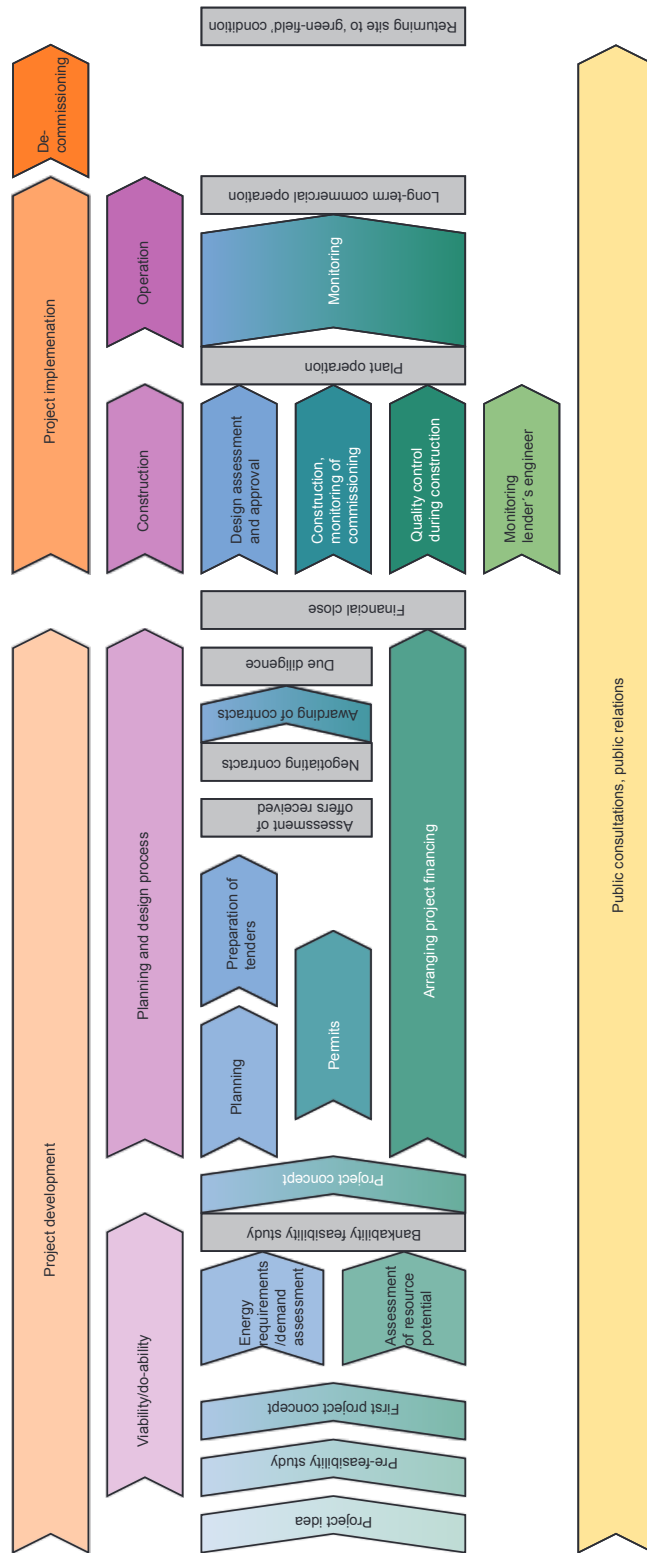


Figure 4.2.1: Schematic illustration of the unfolding of the different stages and processes in a renewable energy project. | Source: VBI.

Normally, after the due diligence review, a so-called ‘lender’s engineer’ is also engaged by the bank/financing institution (the lender) to monitor construction and commissioning on their behalf.

With the involvement of the suppliers or contractors in the project, further significant engineering services for these project participants are required: assistance with the preparation of the quotations for their subcontractors/suppliers; assistance with the detailed design and the actual construction, assembly and commissioning of the plant. These engineering services are either provided by participant’s engineers themselves or sourced out to engineering companies.

After the plant has been commissioned and put through a successful trial operation, the construction phase ends and the operational phase begins – the on-going commercial operation of the plant. Engineers are involved in various ways – engaged by different parties both in the actual initiation and in the supervision of plant operation, in collaboration with the plant operator, the general contractor, the owner and the investors. Usually this involves continuous or intermittent monitoring of plant operation, initially with the aim of being granted a so-called ‘preliminary acceptance certificate’, and subsequently, during the guarantee period, until the so-called ‘final acceptance certificate’ is granted. Both certificates are issued and signed by suitably qualified and certified engineering companies, who are contracted by the owner of the power plant. Very often this is the project owner’s engineer or a combination of owner’s engineer and other specialised engineering companies/individuals. Engineers are also involved at various other points during the entire operational phase, in plant operation and maintenance activities (O&M). In addition, the operational phase of the project often involves subsequent upgrades, renovation work or other improvements for which engineering services are required. A sustainable and environmentally-friendly project process will also include the final decommissioning of the plant, its correct dismantling and the restoration of the land used for the project to its original natural condition, or finding another economically viable use for it. Public relations work, combined with measures that encourage a positive view of the project by local communities and the general public, also needs to be carried out during the project cycle. Again, the engineering consultant can play a role here – for example, as a communicator regarding technical issues, or providing technical expertise regarding the development and implementation of ideas related to this.

### 4.3 Analysis of potential renewable energy resources

*Andreas Wiese*

An essential part of planning any renewable energy project is the analysis of the available potential renewable energy resources at the project site or in the project area. This applies to all resources for renewables: global solar irradiation for photovoltaics, direct solar radiation for solar thermal power plants, wind speed and thus the energy contained in the wind for wind farms, biomass resources for e.g. wood-fired power or power/heating plants or for biogas and biofuels production, usable geothermal heat for geothermal power plants or ground source heat pumps (commonly known as geothermal heat pumps), and usable water quantities and hydraulic heads for hydroelectric power plants.

In comparison with conventional power plants – which use fossil energy sources based on oil, gas or coal – a comparatively much greater effort is spent on the analysis part of the planning and project development process for renewable energy power plants. The reason for this is that, in contrast to fossil energy resources, renewable energy resources are usually distributed (not concentrated) over a large area, can be intermittent, and generally not in a ‘store’ which can be accessed at any time; this is an essential characteristic of wind and solar resources, the most important renewable energy resources, and, in a limited sense, this is also true for biomass, hydro- and geothermal energy.

The reason this is only valid to a limited extent for biomass is because following harvesting or collection and pre-treatment, biomass is stored in similar way to fossil fuels. Geothermal energy resources, at least for so-called high enthalpy geothermal reservoirs (containing hot water at temperatures several hundred degrees, or steam at a few hundred meters depth), can be described as energy deposits with concentrated, high energy density, just like fossil fuel reserves. Wind and solar resources have a both a stochastic component – they can be analysed statistically but not predicted precisely – and a more predictable component (daily, seasonal, sometimes even over several years, such as the effects of El Niño). The ratio of the stochastic component to the more predictable component depends on the resource – patterns in the variability of solar radiation are usually more predictable than wind speed variability – and on the location; daily wind speed variations are often more pronounced and predictable at coastal locations than at flat or mountainous inland locations.

The degree of accuracy required when assessing the potential of a resource depends on the respective project phase. At the initial concept phase of a project, estimates of



average annual wind speeds or global solar irradiation at the site are obtained from historical data from nearby weather stations or from published sources. However, for feasibility studies which serve as the basis for project financing, one or more independent certified wind and solar surveys are required, based on – at least for wind – a minimum of one year’s onsite measurements.

Resource assessments essentially fall into two categories:

- Surveys regarding the potential in the general area, such as resource potential maps for wind speeds and solar irradiation, or surveys of biomass potential
- Predicted energy yield reports for specific sites/locations.

### Resource potential maps

At the beginning of a renewable energy resource potential analysis for a country, region or municipality, only limited historical data on the resources is usually available to start with. For wind speeds and solar irradiation, this may be obtained from local meteorological stations. Other possible sources of information include government statistics offices; agriculture or forestry industry organisations, which can provide fundamental information on the available biomass potential such as from wood, agricultural waste such as straw,

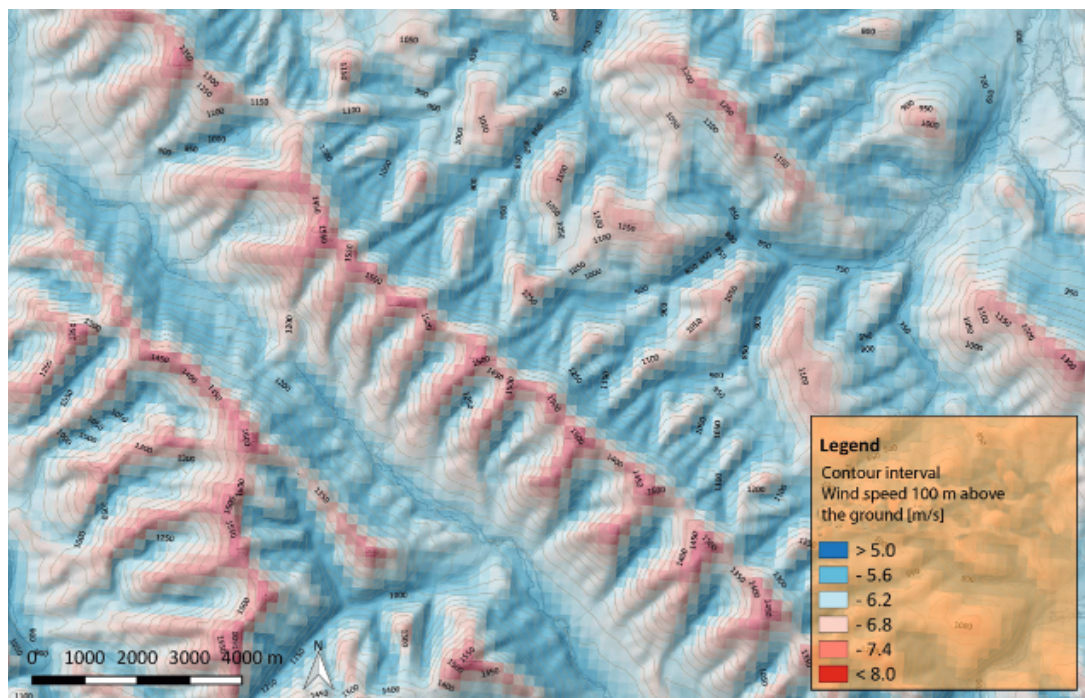


Figure 4.3.1: Example of a map showing average wind speeds at 100 m above ground level in complex terrain. | Source: GEO-NET, Hannover, Germany.

bagasse from sugar production or similar; or statistics from municipalities on organic waste availability. For geothermal energy, the available data on the conditions underground are often obtained from borings/surveys which have been carried out for other purposes, such as prospecting for hydrocarbons. In the initial analysis for a region, the resource potentials are usually mapped in some form; and these days, the information is often processed and presented using a geographic information system (GIS).

Sometimes very complex calculation models are used, especially for the creation of wind and solar resource maps (intermittent energy sources). Making wind resource maps for complex terrains requires the use of so-called mesoscale flow models. This method involves, firstly, using data on geostrophic wind speeds (wind speeds at several kilometres above ground) to estimate/extrapolate wind speeds at near ground-level; then to map these – for example, on 1 x 1 km grid squares and calculate the wind speeds at different heights for each grid square. Subsequently, this wind speed information can be compared with near-ground measurements which have been taken over several years.

### Energy yield assessments

The following is an example of an expert assessment for a potential wind energy project, in which the basic data needed in order to secure project financing, and associated essential tasks for doing so are outlined. The general procedure followed is also applicable to the assessment of other renewable energy resources:

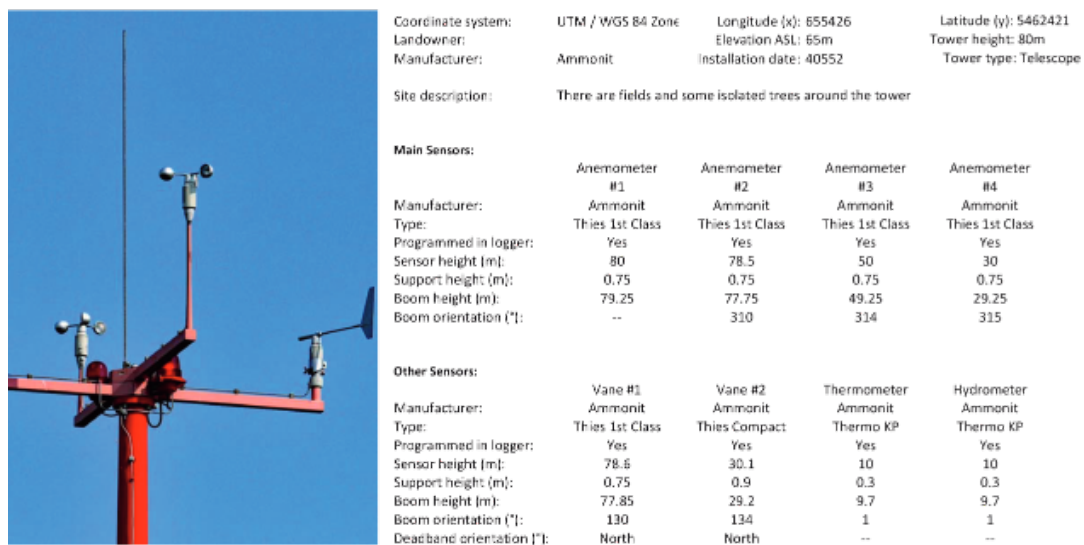


Figure 4.3.2: Specifications for a wind speed monitoring station (right) and wind monitoring mast (left). | Source: Dr. A. Wiese.

### Basic data required

- Site location data – altitude above sea level (to take into account air density and thus the energy content of the wind), terrain roughness, topography
- Site wind speed/direction measurements over at least 12 months
- Long-term data at other nearby similar sites to enable comparisons over the long-term
- Temperature, humidity data, if available.

### Scope of the assessment / essential tasks

- Data validation, plausibility checks
- Seasonal and daily wind speed profiles
- Vertical wind-speed profile
- Turbulence analysis
- Classification of the wind resource at the potential wind farm site into wind classes
- Long-term correlation analysis with other wind data
- Determination of the average annual wind speed and wind speed frequency distribution, usually in the form of a Weibull distribution (probability modelling)
- Determination of potential energy yield: probability of exceedance (PoE) P 50, P 75, P 90.

The probability of exceedance (PoE) indicates the probability that a certain annual energy yield will be achieved. For example, a P 90 value for 100 GWh/a means that at the assessed site there is a 90% probability of at least an annual energy yield of 100 GWh. The bank/institution financing the project will decide whether to base its calculations on PoEs of P 50, P 75 or P 90, depending on its willingness to take on risks. Yield assessment reports are usually prepared by an expert who is certified in compliance with DIN ISO / IEC 17025: 20051, which specifies the general requirements for the competence to carry out tests and/or calibrations, including sampling.

### Wind and solar irradiation monitoring

Monitoring surveys (taking actual measurements at a potential site) are essential for creating the resource potential maps and the yield potential assessments which often serve as the basis for project financing, and are an important engineering task. The sensors, whether for measuring solar irradiation or wind speeds, must be certified to

certain quality specifications. The same applies to the wind speed monitoring station (an example is shown in Figure 4.3.2) and at what height(s) measurements are to be taken. For example, in order to produce a wind resource assessment which would be accepted by banks/financing institutions, the wind speed measurements are ideally made at the hub height of the proposed wind turbine(s) (or at least 2/3 of hub height). As regards for how long measurements should be taken, the longer the better; however, at least a complete cycle covering all relevant seasons (usually a year) should be measured and enough data should be collected so that reliable comparisons can be made (for long periods of time) with data from comparable sites [4].

#### **4.4 Energy demand and load analysis**

*Andreas Wiese*

Another essential component of the engineering planning and design work for a renewable plant or system is to determine how much energy should be produced by the plant and how much power it shall provide. In other words, the expected energy demand and load. Such studies are called energy demand/load assessments and forecasting. Energy demand is the energy needed over time and the load is the energy needed at a specific moment (power).

The type of 'energy service' is to be provided by the renewable energy plant needs to be determined. Energy service can be defined as the direct physical benefit of providing the energy; benefits that can be derived from a combination of the energy produced with energy efficient technologies; and it can also include the necessary operational, maintenance and service and control activities necessary to deliver the energy service. For example, an energy demand analysis could be to determine space heating requirements (how many days buildings are to be heated and to what room temperatures), or during which time periods lighting is to be provided and at what illumination levels.

The findings of the energy demand/load analysis cannot be used directly for the detailed design of a power plant; this is usually limited to an appraisal of the necessary electrical, thermal and/or mechanical energy demand/load.

In some cases, there is no need for an energy demand/load assessment because of the regulatory framework or incentive mechanisms in place. For example, in Germany, with systems that feed electricity into the grid within the framework provided by the Renewable Energy Sources Act (EEG), the electricity has to be accepted by the grid and paid for, regardless of how high the specific demand for electrical energy is at the site/

location where the renewable energy system is situated. However, where there are no guaranteed feed-in tariffs, an energy demand/load assessment is the essential basis of the feasibility of a project – if there is no energy demand, with respect to load, there is no need for a renewable energy system or plant; not only from a business point of view, but also from a macro-economic point of view.

Before carrying out an energy demand/load analysis various items have to be clarified. Two of the most important are: what exactly is being assessed (type and scope of the assessment/analysis), and the level of detail required.

The main types of energy demand/load analyses/assessments are essentially:

- National energy demand/load analyses – which, for example, provide important information about requirements for future power plant capacity
- Municipal/local energy demand/load analyses – which assess the energy demand and load of an urban/suburban or rural area
- Site-specific energy demand/load analyses, – which, for example, assess the energy demand and load for an industrial facility
- Plant-specific or process-specific demand and load analyses – for example, the energy demand/load for a specific process in a chemical plant or required by specific equipment in a chemical plant or machinery/equipment in an industrial park
- Building energy demand/load analyses – typically carried out with the aid of computer software support to determine space heating requirements, hot water requirements, and electrical energy demand or load in residential and non-residential buildings, with the aim, for example, of deciding how a building heating system, CHP plant setup or heating network arrangements can be designed.

For all these types of energy demand/load analyses, the procedure is basically similar:

1. Compiling information on energy consumers and consumer groups (type, number, location, etc.)
2. Determination of peak loads for individual consumers or a typical consumer group
3. Determination of typical consumer load profiles – essentially determining when energy is consumed, and how much
4. Determination of the annual energy demand per consumer or consumer group
5. Energy demand aggregation
6. Determine the total peak load, using simultaneity/diversity factors.

### **Example of energy demand/load analysis for an industrial facility intending to convert entirely from fossil fuels to renewable energy sources**

Firstly, electrical and thermal loads and energy demand need to be ascertained. This includes the load assessment, and, based on this, the maximum power requirements and total annual energy demand assessment. Annual load curves can be used to give rough estimates, but daily load profiles should be used for a detailed system design. Usually, the latter will show energy demand on typical working days, on weekends and holiday, and differentiate between summer and winter demand. This data is used to determine the parameters for the design of the renewable energy system, such as (for both thermal and electric requirements): peak load, annual energy demand, six typical daily cycles (workday, Saturday, Sunday, each for at least two typical seasons, summer and winter) with hourly averages, and an annual load curve.

These parameters serve, first of all, to help decide which renewable energy resources could be suitable for the new energy project and which would not be. For example, if the energy demand in summer is above average and the facility only operates during daylight hours, supplying part of the energy from photovoltaics would be more appropriate than would be the case if the facility operates around the clock and/or has higher energy requirements in winter. The parameters are also subsequently used to design the renewable energy system, and in particular to determine the residual load (the load that still needs to be covered when the power available from renewable power sources cannot cover the total load that needs to be supplied). This is particularly relevant with regard to electrical energy demand; storing energy by any method, such as in the form of chemical or potential energy, usually means very high additional cost; thus, it is always preferred to generate electricity directly at the moment it is required.

Any residual load is then either covered by electrical energy from the grid or from another on-site electrical energy supply based on a storable energy source such as, for example, a combined heat and power plant (CHP) or a gas turbine. In our example, where 100% of energy demand is to be covered from energy from renewable sources, this could be a biomass power plant, or biogas-powered combined heat and power plant. Only if this is not possible for any reason or not economically viable, will storage options be considered to cover – together with an additional electricity conversion device – the residual load curve.

In general, the procedure for carrying out an energy demand/load analysis for a renewable energy project is more or less the same as for any power or energy supply project. However, one important particular issue in relation to renewable energy projects is the time-dependant instantaneously available usable energy/power from an intermittent renewable source versus the time-dependency of the load, i.e., the energy demand, should no form of storage be present.

Essential supplementary data needed for further planning are the following:

- Electric energy/load demand: annual electricity requirements, electricity demand profile over time, quality of supply (technical availability, outage probabilities, voltage and frequency quality, etc.), number and location of customers
- Heat/cold requirements: annual heat demand/load, annual cold demand/load, temperature levels required, pressures requirements if necessary, load profile over time, number and location of customers
- For typical renewable energy power plant projects (wind farms, hydropower plants, PV power plants, CSP plants, biogas or biomass-fired power plants, and geothermal power plants providing electricity-only): required power rating capacity, how many hours per year is the power to be delivered (annual power requirements), requirements for compliance with specified network standards
- For combined heat and power (CHP) plants, in addition: annual heat demand and load, times dependency of demand, respectively.

In the box an example of an industrial facility whose energy supply is to be converted completely from fossil fuels to renewable energy sources is described.

## 4.5 Selecting routes for power transmission lines

*Walter Wakolbinger*

Selecting and deciding on the routes for large power transmission line infrastructure is becoming increasingly difficult, especially in densely populated countries such as Germany. From initial feasibility study to planning approval and construction is a long-drawn-out process. The various interests of the stakeholders involved need to be reconciled – all the interest groups have their specific concerns, most of which are which are understandable and justified. Balancing all these interests and legally protected rights and then developing an economically feasible and ecologically acceptable power transmission line route requires a sophisticated methodology. If the final decision is to be accepted by all parties, the process needs to be transparent and traceable.

In order to take all this into account, when the SuedLink project (HVDC transmission lines taking electricity generated by wind power in the north of Germany to the south of Germany) was being planned, a GIS-based spatial resistance analysis (constraint mapping) was carried out and an online planning participation platform was designed and used. When developing and selecting a suitable route for a power transmission line, many different constraints must be taken into account. These include environmental protection requirements, spatial and regional planning issues, but also social issues, natural hazards, technical construction issues and the already existing infrastructure, etc. Considering these constraints individually and in isolation from each other can often be misleading and lead to erroneous conclusions.

In order to enable a holistic approach to this problem, ILF Consulting Engineers has developed a GIS-based corridor analysis method by utilising ArcGIS Cost Distance analysis tools (please note that in GIS language resistance factors are also referred to as costs) with which the geographical area being assessed for projects can be analysed in a structured and semi-automatic way.

### Combined constraint map

GIS cost analysis tools are usually grid-based. Therefore, the area of interest is split into a grid where the chosen grid size depends on the type of project to be analysed as well as on the available level of detail of the considered constraints. In many cases, several constraints regarding e.g. land use, protected areas, etc., but also technical constraints, such as steep terrain slopes or soil that is difficult to dig/excavate, will overlap. These overlapping constraints – which first need to be quantified/weighted (given a value) – need to be combined with each other. There are two possible methods



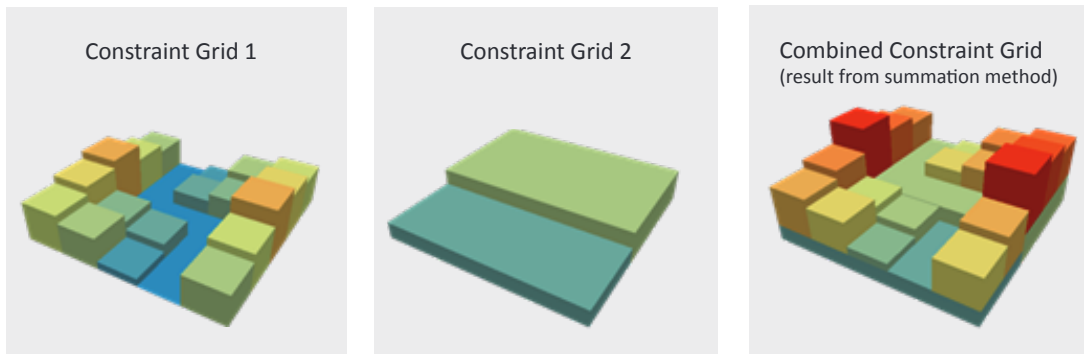


Figure 4.5.1: Combination of different constraint values using the summation method. | Source: ILF Consulting Engineers.

for combining these constraints in order to obtain a total value for each grid position: the ‘summation’ method and the ‘maximum value’ method.

With the ‘summation method’, all congruent grid values of the overlapping constraints are added together, as illustrated in Figure 4.5.1. In areas where many individual constraints overlap, the summation method can lead to very high constraint values. In Germany, multiple overlapping areas with constraints regarding land use are quite common; for example, the overlapping of nature reserves, ‘Natura 2000’ areas (EU nature protection areas) and other areas where there are planning constraints and priorities. This often leads to undesirable results because the model algorithm will attempt to avoid these areas to a greater extent than is necessary; and this is counter-productive to the goal of determining the shortest and most straightforward corridor for the transmission line.

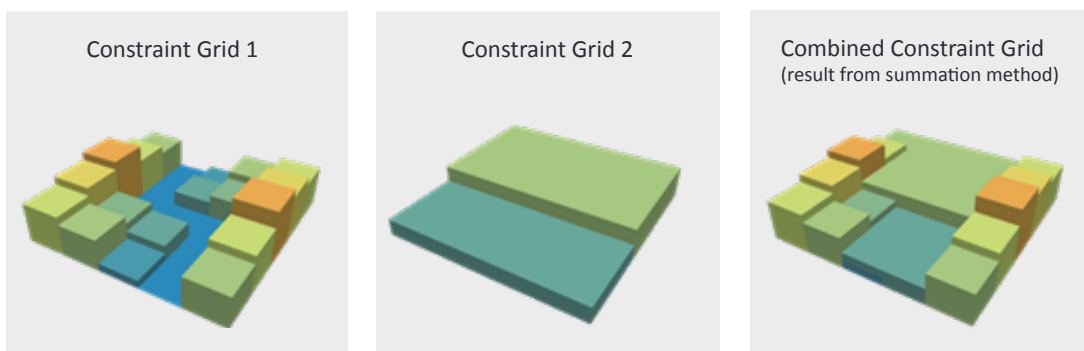


Figure 4.5.2: Combination of different constraint values using the maximum value method. | Source: ILF Consulting Engineers.

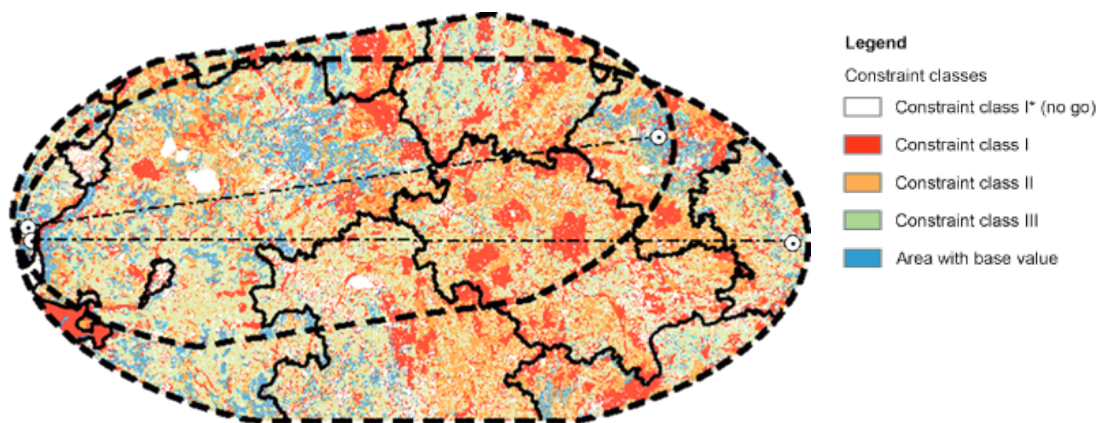


Figure 4.5.3: Example of a combined constraint map arrived at using the maximum value method. | Source: ILF Consulting Engineers.

The ‘maximum value’ method is illustrated in Figure 4.5.2. Using this method, from all congruent grid values of the overlapping constraints only the highest value is selected and will be assigned to the related grid position; all other constraint values will not be considered.

Because the group of constraints dealing with environmental and planning criteria and the group of constraints dealing with construction criteria describe completely independent aspects of the geographical area being assessed for the transmission line route, each group is treated separately. For each group, the combined constraint grid will be calculated using the ‘maximum value’ method. The resulting grids will be combined, again using the ‘maximum value’ method. The result is a combined constraint map that represents both the constraint values of environmental and planning criteria with construction criteria. Using the summation method would result in constraint

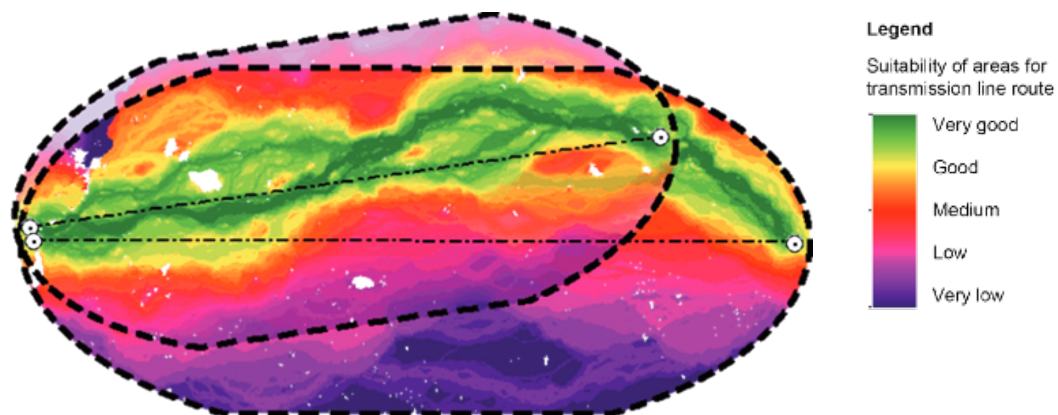


Figure 4.5.4: Structured planning area. | Source: ILF Consulting Engineers.

values that would not be justifiable from an environmental or legal point of view. An example of a combined constraint map arrived at using the maximum value method is shown in Figure 4.5.3.

### Structuring the planning area

However, the combined constraint map still does not provide a conclusive statement about suitable approximate routes for a possible transmission line corridor. For example, it may be more economic to pass through short sections of areas with high planning constraints if the length of transmission line corridor can be shortened.

To solve this problem, a cost-distance grid is computed for the entire planning area. For each grid position, the shortest weighted distance to the starting point of the transmission line is determined as a function of the constraint values adjacent to and surrounding that cell.

The areas with the lowest accumulated constraint values (dark green) are best suited for power transmission line corridor (see Figure 4.5.4); as the values increase (from light green to purple), the potential for conflict regarding the line route increases.

## 4.6 Project management

*Christopher Vagn Philipsen*

The engineering services that are required at each phase of implementing a renewable energy project (feasibility study, design, construction and operation) are described in detail in the corresponding chapters of this guide. Figure 4.2.1 illustrates the complexity of project handling across the different project phases.

Because of the range of activities needed to complete a renewable energy project, a holistic approach is required. The main project issues – such as plant technology and capacity, possible locations, licensing issues, financing / promotion / business plans, infrastructural connection and grid connection, environmental aspects, etc. – need to be investigated and clarified early in the project. On the basis of this initial work, the aims and objectives required to successfully implement and complete the project – such as available budgets, completion date(s), quality requirements, and project economics – can be formulated.



Figure 4.6.1: The so-called project implementation 'magic triangle'. | Source: Drees & Sommer.

Project management covers the entirety of all the issues related to the construction and commissioning of a renewable energy plant in accordance with the agreed specifications. This includes on-going monitoring of work in progress in relation to plan targets, making sure that all equipment and contracted-for services are delivered, identifying possible solutions regarding any deviations from the original plan, and making final decisions regarding these solutions.

The relationships between the individual activities involved in project management are shown in the so-called 'magic triangle' of project implementation (see Figure 4.6.1). This illustrates potential areas of conflict between cost optimisation, project deadlines and quality control management with regard to the achievement of the project goals. It illustrates the essential project management aspects and tasks for activities, quality assurance, costs and deadlines. Optimising these activities is achieved through interface management and by the appropriate structuring of organisational, coordination, documentation and information requirements. Other essential issues and tasks, which are not discussed in detail here, include risk management, 'building information modelling' management (BIM management), 'lean design management' (LDM) and 'lean construction management' (LCM), approval management, land management and public relations.

The main challenge for project management is coordinating the different wishes and ideas of those involved in the planning and construction of the plant – clients, design engineers, consultants, appraisers, construction companies, technical and approval

authorities, public, etc.) – and to achieve this in such a way that the project objectives can be realised, and to do so consistently, taking into consideration the possibility of unforeseen external events/factors. The client needs to have their own in-house personnel with the relevant skills capacities or, if this is not the case, must be able to source personnel externally. The costs of project management are dependent on the specifics of individual projects and on the scope of tasks in the individual activity areas. Depending on project size and complexity, project management costs can be calculated as being approximately 1 – 3% of the overall project budget.

### **Organisation / coordination / documentation / information**

One of the main project management tasks is the setting up of an organisation structure appropriate to the requirements of the project. This includes specifying the following: who is entitled to make decisions and what decision-making procedures should be followed; who is to perform specific tasks; what expertise is required by the various project participants, and what their responsibilities will be. Because of the relatively high number of actors and stakeholders involved in a typical project, a high level of co-ordination is required.

With larger and complex projects in particular, experience has shown that it is a good idea for the client to set up a project-specific organisation, independent from their general organisational structure. This makes it easier to source required personnel and to make better and faster decisions within the project. Setting up procedures and standards to be followed during project implementation (regarding meetings and reporting requirements, decision-making, relaying information to project participants, etc.) will facilitate the work of project management considerably.

The organisational structures and processes which have been decided upon should be laid out in a project-specific organisation manual, which should be kept up to date. The use of an internet-based virtual project space is also recommended. This can ensure that all project participants have constant access to the most up-to-date information that is important to them; and, simultaneously, keep the project management informed on the current status of work, and thus be in a position to quickly implement appropriate control measures if there are deviations from the work plan.



Figure 4.6.2: Project participants' network of interrelationships. | Source: Drees & Sommer. | Graphic: RENAC.

### Costs and financing

The project managers always need to have complete access to all information relating to project costs. These include all the ancillary costs related to planning/design and construction work (such as development costs, legal and other fees, the cost of land, compensations, indemnities, etc.). At the beginning of the project, it is essential to define the criteria that will be the basis for cost and cash flow monitoring. This means that these will be transparent to all those involved; such as, for example, what the procedures will be for allocations and for plant and equipment related accounting, and what criteria will be used when cost calculations are subsequently being reviewed.

The use of a project-specific control system for cost and cash-flow planning and monitoring that is tailored to the commercial requirements of the project (regarding financing, subsidies etc.) is recommended. This will ensure, for example, that sub-project structures are taken into account when organising budget data, order data and billing data, and that this data can be appropriately evaluated.

## Schedule management

Schedule management and planning need to be carried out in close cooperation with the various project participants, as they are the basis for the effective monitoring and control of time-relevant tasks/processes. The ability to adapt to changing circumstances must be possible at all times. Adherence to the project schedule – in particular to the ‘critical path’ (defined as those processes/tasks which, if delayed or interrupted, will impact negatively on the completion date of the work) – needs to be closely monitored by project management. In the case of deviations from deadlines, project management needs to draw up the remedial measures required and, in consultation with the general contractor, implement them.

Usually, project schedule management takes place on different levels:

The so-called **milestone plan** covers the entire duration of the project and lists only the most important deadlines.

The **master schedule**, which also covers the entire duration of the project, specifies the ‘critical path’ as well as the capacity framework (expertise and resources necessary to plan and implement), logistical variables and other issues. **Rough schedules** delineate the key completion dates for the main phases of the project (such as design, planning or implementation), and contain more detailed information regarding specific tasks/procedures, coordination requirements and the ‘critical path’. They also contain the delivery/completion dates which have been contractually agreed with designers/planners and firms carrying out specific works. Finally, there are the more detailed **control and implementation schedules**; these specify the very accurate schedules and monitoring procedures required for specific project phases. IT tools for project scheduling and monitoring are available and their use is recommended. An ‘open item list’ database system (which enables one to keep track of activities) should be used to enable project participants to sequence and monitor jobs.

## Quality control management

Quality control should begin during the first phases of a project (the project design/planning phase), when information for the project is being collected and the project goals are being formulated. Thereafter, as the work progresses, the project management needs to perform quality checks at the pre-agreed workflow milestones (quality gates) to ensure that all design and implementation aspects of work are being completed in compliance with the quality specifications. Project management coordination activities

include not only managing work schedules and the budget, but also the coordination of a whole range of technical issues (such as construction site available/access, traffic/logistics during construction works, the compatibility of different construction methods/conditions on different parts of the site, and the coordination of the activities of different contractors/suppliers, etc.).

#### **4.7 Bankable feasibility study**

*Jens Kottsieper, Manfred Watzal*

The ‘bankable feasibility study’ assesses the economic viability and credit-worthiness of a project. The aim is to provide an overall view of the project that will demonstrate its profitability to investors and its ability to repay loans to lenders such as banks. The bankable feasibility study is an essential part of the project development phase. It differs from the technical feasibility study in that it examines *all* aspects of a project in order to confirm project income streams and thus enable the project to be *financed*.

The bankable feasibility study determines whether there is a requirement/demand for the project, whether the necessary resources are available, the suitability of the site/location, the technical solution proposed, the economic viability of the whole project, also with a view to understand the risks that can be incurred during construction and operation period. At the same time, the bankable feasibility study has the task of identifying political risks (risks associated with changes in public policy) at an early stage and what countermeasures can be taken to mitigate them. The study also includes a financial model / project business plan which is compatible with the suggested project capital structure and any fiscal regulations it has to abide by.

The proprietor of the bankable feasibility study is an investor. The addressee is often a bank (hence ‘bankable’). Another addressee may be a public authority to whom it must be demonstrated that the project can or should be approved. The investor prepares the bankable feasibility study initially for their own use, but ultimately also to make it the basis for negotiating with interested other possible investors or banks, with the aim of financing parts of the project via borrowed capital. Banks are interested in gaining an insight into the market situation and how secure the project income will be so as not to jeopardise loan repayments. Particular emphasis will be placed on risks that can arise during construction and operation. The bankable feasibility study also assesses any relevant incentive mechanisms (see Chapter 2.3 Incentive mechanisms),



which are imposed by in the country in which the project is to be implemented. The investigation of incentive mechanisms is especially important in markets in which incentive mechanisms are in place but in which demand is latent or low, and where market stimulation or market development is necessary. Investors, capital providers or banks can only respond to these incentives. From the results of a bankable feasibility study, it is possible to assess to what extent pricing regulations or other regulatory measures favour or hinder business models or render them impossible.

If a project's income structure is based on a power purchase agreement (PPA), the bank also, for example, needs information regarding the power purchaser's credit-worthiness. The power purchaser should be able to guarantee payments over the entire period during which the project requires bank funding. The commitment of a power purchaser who is in a financially strong position means a significant reduction in market risk, thus strengthening the project owner's negotiating position with the bank.

The bankable feasibility study considers project financing for the entire duration of the project, from the start of the project development phase through to the planning, design, construction and end of its operation. If, eventually, the plant is no longer state-of-the-art and no longer competitive in comparison to newer systems, it is then decommissioned and/or replaced. These decommissioning and dismantling costs also need to be considered in the profitability analysis, and typically reduce the return on investment.

## **4.8 Energy use plan**

*Bettina Dittmer*

The German energy transition – from fossil fuels towards renewable energy – is attracting widespread international attention. Climate protection, increasing scarcity of resources, and the growing need for electricity and heat, are the main drivers. Because renewable energy technology is developing at a rapid pace, it is very important that the country's regional and urban planning authorities are in a position to provide a long-term regulatory framework. The goal is the development of regulatory frameworks that coordinate overall regional and urban planning with regional energy infrastructure planning, and thus enable the best use of available resources while at the same time strengthening regional autonomy.

The prerequisite for all this is a clear formulation of what is required – beginning with a definition of goals, an analysis of the current situation, and the forecast level of energy

demand. Climate protection requirements, other environmental issues, and economics need to be reconciled. The entire lifecycle of each measure – for example, from the building of a facility, its working life, through to final demolition, including disposal and recycling – needs to be considered. The end result of this process should be a customised plan which includes a summary of agreed objectives and an implementation strategy. Effective public consultation procedures have a strong influence on the success of such projects (see Chapter 4.9 Public acceptance management for international infrastructure projects).

An ‘energy use plan’ (German = *Energienutzungsplan* – other countries use different terminology) is an overall planning framework aimed at regulating, coordinating and optimising energy supply and environmental compatibility, that can be deployed to successfully implement the complex transition to sustainable energy production and use at the level of regions, urban neighbourhoods and communities. Prerequisites for the successful implementation of an energy use plan are the coordination of the activities of public authorities (policy committees, specialist planners, planning offices), other stakeholders (utilities, etc.), and the effectiveness of public consultations. Energy use plans of this type are already being implemented successfully in parts of Germany; and pilot projects exist in Denmark, France, Ireland, Japan, Canada, Austria, the Netherlands, Norway, Switzerland and the USA.

### **Energy use plan – description**

An energy use plan should outline a holistic energy concept for implementing the transition to sustainable energy production and use, including energy planning goals, in conformity with the local land-use development (zoning) plan. The overall goal – for municipalities, energy suppliers, investors and private individuals – is to reduce energy consumption, increase energy efficiency and integrate the use of renewables into the energy supply system. The plan systematically specifies the future energy-related development of the district for which the plan is designed, with regard to expected future energy consumption and future urban development plans. The objective is the coordination and integration of all the local available and potential energy resources and development of an overall energy concept which is compatible with environmental requirements, while simultaneously making these objectives transparent to the general public.

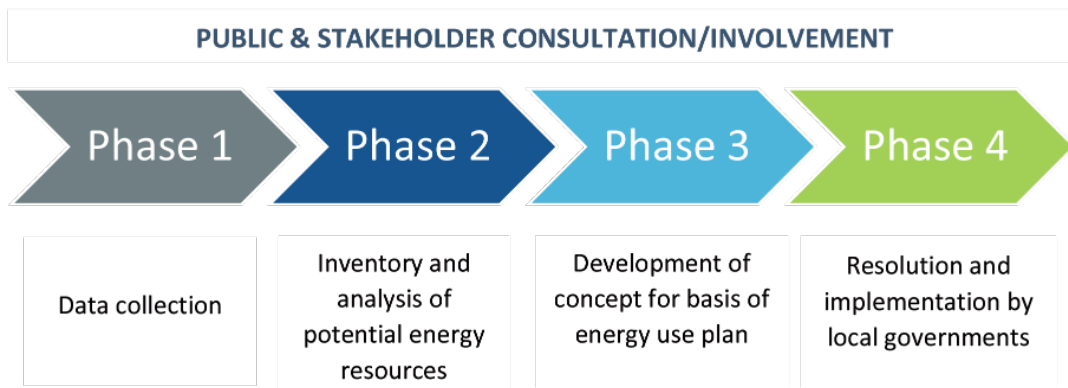


Figure 4.8.1: Phases of an energy use plan. | Source: Dittemer.

## Development of an energy use plan

An energy use plan can be divided into four phases (see Figure 4.8.1).

### Phase 1: Data collection

This preparatory planning phase forms the basis of the entire planning and implementation process of the plan. It includes the collection of all data necessary for an analysis: land-use plans, building plans, development plans, inspections documentation, lists of building stock, lists of public real estate, businesses, and facilities requiring approval, as well stating what further necessary data may be required. The result of this first phase is a work plan/map comparable to a land-use map.

### Phase 2: Inventory and analysis

An inventory of all energy-related data, including potential energy resources, and its spatial distribution in the plan's geographical area (municipality, district, region) needs to be compiled. The energy demand/consumption of the building stock need to be assessed. Details of the energy network infrastructure and other energy resources needs to be documented. The general public and businesses should be involved in this via the use of surveys. Then, development plans and information on future expected energy demand/consumption requirements are used to augment and complete this initial analysis. The result should be a detailed inventory of energy-relevant data for the geographical area for which the plan is being drawn up (see Chapter 4.3 Analysis of potential renewable energy and Chapter 4.4 Energy demand and load analysis).

### **Phase 3: Concept development**

On the basis of the inventory and associated research, plausible future scenarios can be developed, which fit current and expected energy demand/consumption, the existing infrastructure and potential renewable energy resources.

When developing an overall concept, the focus needs to be on energy savings, available renewable energy sources, possible synergies, the coordination possibilities of available resources, and integrating energy planning with urban planning processes.

Areas can be identified where district heating networks might be appropriate or not, and where action may be required to facilitate cooperation/coordination between different local/communal authorities. Likewise, proposals for building/infrastructure renovation measures and options for efficient heat supplies can be outlined. Essential components of the overall concept will be such matters as the spatial allocation of energy supply facilities and the issue of whether decentralised or centralised heat supply systems are the most appropriate option. The close integration of urban planning and energy planning is necessary to achieve a sustainable settlement and land-use development. This requires future development scenarios to be examined/modelled. The results of these analyses, and the energy concepts which have been examined and developed, including alternatives, are then summarised and presented in an energy use plan in the form of maps and explanatory texts.

### **Phase 4: Conclusions and implementation**

When the local authority or municipality has decided to adopt the energy use plan, it can be implemented; and it can now serve as the basis for further planning procedures with regard to land-use (zoning), building projects, and specifications for building contracts. The success of an energy use plan depends on its acceptance by the general public. As many stakeholders as possible should be involved right from the beginning. This involves publicising the plan via the local press, stakeholder consultation and involvement, information events and citizen forums (see Chapter 4.9 Public acceptance management for international infrastructure projects).

There is room for improvement worldwide with regard to the assessment of whether the objectives of energy use plans are being achieved. On-going monitoring parallel to the implementation of plans is, as yet, rarely carried out. Monitoring how plans are

unfolding/being implemented can be crucial, especially with regard to updating local climate protection objectives [5]– [9].

#### **4.9 Public acceptance management for international infrastructure projects**

*Christian Semmler*

In infrastructure projects involving international developers there are often tensions between project management, investors and local stakeholders, because the various stakeholders perceive different aspects of a project differently. This can lead to delays in project implementation and additional costs. Sometimes there can be public disputes that can have a negative impact on the image of the companies involved, and also impact negatively on public relations efforts to promote the acceptance of a project locally. 'Public acceptance management' refers to all those activities related to informing and consulting with local stakeholders and the general public in order to promote a project by avoiding misinformation, misunderstandings and dealing with controversial issues. When addressing these issues, the key points discussed below should be considered

##### **Local presence**

Companies that have well established local contacts and have a local presence can initiate important working relationships before the project starts and therefore can more easily address problems which may emerge during the project's life. An example of this is when a healthcare company wanted to implement a project at a foreign location; before the project began, it established itself in the regional structures over two years, thereby gaining trust; the project started successfully, and any unforeseen misgivings/resistance could be smoothly resolved through social contacts that had been made and sustained during that time.

##### **Before project start: assessing the stakeholders**

Knowing the identities of the stakeholder holders, and their interests, at the outset of a project enables the early recognition and evaluation of misunderstandings and uncertainties which may emerge during the course of the project. Knowing which stakeholders in the project environment can influence the success of a project can also be useful in counteracting misunderstandings and acceptance problems at an early

stage. Regular reevaluations of the situation should be conducted throughout the project life.

### **Appropriate communication strategies**

To improve communication with decision makers and local stakeholders, international project developers need to address the question of which communication strategy can best promote the local acceptance of a project. Unfortunately, there is no simple recipe for achieving this: communication strategies need to be tailored to the nature of each individual project. But in principle, a distinction should be made between unilateral ('top-down') information (e.g. public relations) and two-way dialogue communication (e.g. public/stakeholder consultations and conversations). Here are two examples:

- Impressions from a study covering Germany, the Russian Federation and Ukraine [11] reveal that citizens in the eastern European countries expected less active public consultation/participation but, above all, expected to be provided with consistent information about projects. One reason for public opposition to projects was that citizens felt they were not kept properly informed, not informed at all, or only inconsistently. In situations where these are the expectations, systematically updating citizens improves project acceptance.
- Somewhat different was the experience of a German wind energy project. 'We kept people informed during the whole of the project!' said the project manager, but because of controversy surrounding the project, pursuing a communications strategy of 'only providing information' merely increased public misgivings. Here, perhaps, a two-way dialogue strategy that would have enabled a more active and participatory approach to addressing public concerns, could have achieved more successful outcomes.

### **The right degree of stakeholder involvement**

What is the right degree of involvement (inclusion/consultation) with the relevant stakeholders in international infrastructure projects?

An excursion into the world of work might be useful in throwing some light on this question. For example, in many Western countries, a high level of employee satisfaction depends upon employees' opportunity to have a significant say in the decision-making process. However, in many cultures where there is a so-called high 'power distance' [12], usually the employees have less say in major business decisions; these are made

by management, and this is accepted by large segments of the workforce. Does this mean there should be no involvement of relevant stakeholders or citizens in projects in countries where there is so-called high ‘power-distance’? [13]

In the course of a survey carried out in China, employees were asked how much their work satisfaction depended on their ability to have a significant say in the running of their workplace [14]. It showed – as expected – that persons with a high ‘power distance’ need did not expect to have a significant say in major business decisions and yet were satisfied with their work. However, other respondents had a lower ‘power distance’ expectancy, and expected to have a say, which had a positive impact on their job satisfaction and performance. It can be reasonably deduced from this that even in countries with a culture of higher ‘power distance’ there are stakeholder groups whose political-economic satisfaction depends on having a voice in decision-making regarding international infrastructure projects.

A good example of an appropriate level of stakeholder involvement in a complex project was a project in Peru [15], which concerned the modelling of the future water supply of the capital, Lima. Because of the multidimensional nature and complexity of the issues and questions involved, a participation-oriented approach was taken that involved relevant stakeholders such as ministries, local administration, companies, as well as representatives from academia and civil society. This approach led to a viable resolution that was accepted by all parties. Corporate and other standards now exist concerning early public participation [16] and responsible practices in connection with investment in rural areas [17]. These contain recommendations about the transfer of land rights, compulsory purchases, dealing with indigenous people, and other issues. Applying these standards is voluntary, but adhering to them has proven itself in project-implementation experience. The standards comply with international law, and were developed within the Food and Agricultural Organisation (FAO) in a consultative process with representatives from 133 countries.

### **Financial and material participation**

Financial participation is a form of stakeholder inclusion that involves concrete participation in a project. This form of participation can be practicable for broad sections of a population. Such participation can be offered in very different forms:

- Project-based citizens’ cooperatives
- Crowdfunding for construction projects [18]

- Issue of company- or project-related savings bonds [19].

However, these models do not usually work if broad sections of the population have little disposable capital. Making microfinance loans available to enable participation might be an option in developing countries [20].

### **Transparency pays off**

An important component of public acceptance management is high-quality communication. This is based on the following four pillars:

- Inform as early as possible
- Inform proactively, and do not withhold information – especially in critical situations
- Communicate transparently and authentically
- Always comply with legal requirements.

The following are examples of how a German wind energy project developer, with offices in Europe, Argentina, Canada and Iran, practices proactive public acceptance management [21]:

- Many projects have their own project webpage, which which include project goals, wind farm site plans, and statements addressing public concerns
- The project manager and press spokesperson for each project site are named and it is possible to contact them. Concerns by members of the public can thus be responded to quickly [22]
- Press releases are tailored to the different information needs of investors and the general public.

Naturally, a professional and transparent communication strategy involves higher project costs. However, the benefits it brings are undeniable: journalists can obtain relevant information at any time, and this can quickly answer/resolve initial questions in communicative crises. From a project developer's point of view, this saves time, and transparency conveys confidence to critical stakeholders. Initial tensions associated with a potential crisis can thus be mollified. It is advisable and worthwhile to carry out a comprehensive analysis of the possible impact of a transparent and differentiated project communication strategy on the project budget, on project deadlines, and on the corporate image of the project developer.



## References

- /1/ CERAWeek in March 2018.
- /2/ [https://www.energy-charts.de/energy\\_pie\\_de.htm](https://www.energy-charts.de/energy_pie_de.htm) and <https://de.statista.com/statistik/daten/studie/217056/umfrage/ziele-des-erneuerbare-energien-gesetzes/>.
- /3/ <https://de.statista.com/statistik/daten/studie/217056/umfrage/ziele-des-erneuerbare-energien-gesetzes/>.
- /4/ <https://de.statista.com/statistik/daten/studie/217056/umfrage/ziele-des-erneuerbare-energien-gesetzes/>.
- /5/ Kaltschmitt, Streicher, Wiese: Erneuerbare Energien – Systemtechnik, Wirtschaftlichkeit, Umweltaspekte, 5. Edition, Spingerverlag 2012.
- /6/ Leitfaden Energienutzungsplan, Herausgeber: Bayrisches Staatsministerium für Umwelt und Gesundheit, Bayrisches Staatsministerium für Wirtschaft, Infrastruktur, Verkehr und Technologie, Oberste Baubehörde im Bayrischen Staatsministerium des Innern, Stand: Februar 2011. Download unter <https://www.stmi.bayern.de/buw/energieundklimaschutz/energieleitfaden/index.php>.
- /7/ *Energienutzungsplan* Esslingen/Neckar, Bericht zum Klimaschutz-Teilkonzept, 29.10.2013, im Auftrag der Stadt Esslingen.
- /8/ *Energienutzungsplan* unter besonderer Berücksichtigung des Denkmalschutzes am Beispiel der Stadt Iphofen, Untersuchung des Potenzials von Nahwärmeversorgungskonzepten in Verbindung mit Sanierungskonzepten denkmalgeschützter, historischer Gebäude in innerörtlichen Quartieren, Forschung im Auftrag des BBR im Rahmen der Forschungsinitiative Zukunft Bau. Technische Universität München, Lehrstuhl für Bauklimatik und Haustechnik, Prof.Dr.-Ing.Dr. h.c. Gerhard Hausladen, Abschlussbericht Oktober 2012.
- /9/ Strasser, H., J. Kimman, A. Koch, O. Mair am Tinkhof, D. Müller, J. Schiefelbein, C. Slotterback (2017). Implementation of energy strategies in communities, Energy and Buildings.
- /10/ [www.annex63.org](http://www.annex63.org)
- /11/ Research Project TRIPAR (from 2017): 'Participatory and effective urban planning in Russia, Ukraine and Germany', Daniela Zupan, RWTH Aachen University, Fakultät für Architektur, Germany. A first publication regarding this research project is available in a shortened version at <http://www.planung-neu-denken.de/>.
- /12/ 'Power Distance' is the extent to which the less powerful members of organizations and institutions accept and expect that power is distributed unequally. For a deeper understanding of 'power distance' see <https://geerthofstede.com/culture-geert-hofstede-gert-jan-hofstede/6d-model-of-national-culture/> and Culture's Consequences: Comparing Values, Behaviours, Institutions, and Organizations Across Nations by G H Hofstede, Sage Publishing, 2001, 2nd ed., London, UK.
- /13/ For reasons of brevity/simplicity, the concepts 'power distance' and 'individualism/collectivism' will not be further differentiated in this text. For a deeper understanding of the concepts of collectivism etc., see <https://geerthofstede.com/culture-geert-hofstede-gert-jan-hofstede/6d-model-of-national-culture/> and Culture's Consequences: Comparing Values, Behaviours, Institutions, and Organizations Across Nations by G H Hofstede, Sage Publishing, 2001, 2nd ed., London, UK.

- /14/ Brockner, J., Ackerman, G. et. al. (2001). Culture and Procedural Justice: The Influence of Power Distance on Reactions to Voice. *Journal of Experimental Social Psychology* 37, 300 – 315.
- /15/ Detailed description at <http://www.lima-water.de/>.
- /16/ VDI Norm 7000/7001: 'Early public participation in industrial and infrastructure projects' (2015) – this is a German standard but is used internationally. See <https://www.vdi.de/wirtschaft-politik/fruehe-oeffentlichkeitsbeteiligung/>.
- /17/ See <http://www.fao.org/news/story/en/item/260518/icode>.
- /18/ This form of project co-financing by the public has been successfully implemented in offshore wind projects, for example in France, see <https://www.abo-wind.com/fr/abo-wind/index.html>.
- /19/ <https://www.dkb.de/geschaeftskunden/kompetenzen/buergerbeteiligung/buergersparen/>.
- /20/ However, the effects of this option in the social environment should be critically investigated, see <http://www.lendingschool.de/blog/mikrokredite-in-entwicklungslaendern-fluch-oder-segen/>.
- /21/ See <https://www.abo-wind.com/>.
- /22/ <https://www.abo-wind.com/en/the-company/international/united-kingdom/index.html>.

## 5 Economic Viability and Financing

### 5.1 Comparative costs of different renewable energy technologies

Andreas Wiese

The Fraunhofer Institute for Solar Energy Systems ISE in Freiburg, Germany, regularly carries out analyses of the comparative international costs of renewable energy technologies. These analyses calculate, using comparable assumptions for each technology, the costs of investments required, annual fixed and variable costs of equipment, operational costs, maintenance costs, repair costs, and insurance costs. The average annual electricity generation (or heat generation or total energy supplied) by each technology is estimated, based on current state-of-the-art technology.

The ‘levelised cost of electricity, or energy’ (LCOE) generated by each type of renewable energy technology is then calculated. To calculate the LCOE, all initial investments are annualised, (divided into equal annual amounts, usually over the lifetime of the plant). These annualised investment costs are then added to the average annual costs of operation, maintenance, servicing and other costs. The resulting amount is then divided by the average quantity of energy produced annually. LCOE calculations enable an initial comparison to be made between the different renewable energy options which might be suitable to supply energy at a specific site/location [3] [4].

[€/kWp]	PV small (< 10 kW)	PV medium (< 1 MW)	PV large utility scale	Wind onshore	Wind offshore	Biogas	CPV
Investment costs 2019 - low	1,100	800	500	1,300	2,500	3,000	1,400
Investment costs 2019 - high	1,400	1,000	800	1,800	3,800	5,000	2,200

[€/kWp]	CSP-Parabolic without storage	CSP-Parabolic with 8h storage	CSP-Fresnel without storage	CSP-Tower with 8h storage	Lignite	Anthracite	CCTG
Investment 2019 - low	2,500	4,100	2,150	4,500	1,250	1,100	550
Investment 2019 - high	3,500	5,100	2,600	5,500	1,800	1,600	1,100

Table 5.1.1: Current investment costs for solar, wind and other power generating technologies in € per kW; CPV = concentrator photovoltaics; CCTG = combined cycle gas turbine. | Source: GOPA intec, Suntrace, Fichtner.



Figure 5.1.1: Utility-scale PV. | Source: Fotolia.

When calculating the LCOE for renewable energy technologies, the upfront investment costs and the energy produced annually are especially important. There are no fuel costs except in the case of biomass; thus, when making initial comparative analyses, especially when comparing renewable energy technologies with conventional energy technologies, annual operating costs often play a minor role for the renewable technologies.

### Investment costs

Prior to calculating the LCOE, the investment costs need to be estimated. Table 5.1.1 shows the relative investment costs for different energy technologies. In the case of photovoltaics, for example, investments costs (worldwide) range from €500 to €1,400 per kW installed. For CSP (concentrated solar thermal power with energy storage, investment costs range from €4,100 to €5,500 per kW. In comparison with conventional power generation, it can be seen that for some renewable energies, such as photovoltaics, investment costs are in a similar range; while for others, such as CSP, investment costs are significantly higher. The situation regarding investment costs for nuclear power is different. According to a study by Moody's, investment costs for new nuclear power plants in 2012 were up to €4,900 per kW. The investment costs for two new reactors at the Canadian Darlington nuclear power plant was between €4,650 per kW (EPR) and

PV system (standard modules)	Electricity production per kWp
Germany – low solar radiation (solar horizontal radiation – 950 kWh/m <sup>2</sup> a)	920 kWh/a
Germany – high solar radiation (solar horizontal radiation – 1,300 kWh/m <sup>2</sup> a)	1,280 kWh/a
Spain – low solar radiation (solar horizontal radiation – 1,500 kWh/m <sup>2</sup> a)	1,450 kWh/a
Spain – high solar radiation (solar horizontal radiation – 1,800 kWh/m <sup>2</sup> a)	1,700 kWh/a
MENA – low solar radiation (solar horizontal radiation – 1,800 kWh/m <sup>2</sup> a)	1,700 kWh/a
MENA – high solar radiation (solar horizontal radiation – 2,300 kWh/m <sup>2</sup> a)	2,000 kWh/a

Table 5.1.2: Annual electricity generation from PV. | Source: GOPA intec, Suntrace, Fichtner

Wind turbines (2 –5MW)	Mean full load hours per year (h/a)	Electricity production per kW
Onshore - low	1,800 h/a	1,800 kWh/a
Onshore - high	3,200 h/a	3,200 kWh/a
Offshore - low	3,200 h/a	3,200 kWh/a
Offshore - medium	3,600 h/a	3,600 kWh/a

Table 5.1.3: Annual electricity generation from wind energy. | Source: GOPA intec, Suntrace, Fichtner.

€6,850 per kW (Advanced CANDU Reactor) [1]. Most renewable energy technologies entail significantly lower investment costs than does nuclear power. Compared to fossil power plants, the investment costs for renewable energy technologies are in many cases in a similar range.

However, merely comparing the initial investment costs (construction investment costs) for different technologies does not tell the whole story. How much electricity a plant will produce annually is also important. Estimates of this are shown in Tables 5.1.2-5. A 1 kW photovoltaic system in Germany produces between around 920 and 1,280 kWh per year. However, in southern Spain, the same system would produce almost 1,700 kWh per year. A CSP plant with 16 hours of energy storage capacity at one location in the MENA region (Middle East and North Africa) region can supply almost 7,000 kWh of electricity per year per kW of installed capacity; and because the plant includes energy storage, it can deliver power at all times, which is not the case with wind or PV (wind turbines do not produce when there is no wind, and PV does

CSP plants (100 MW)	Direct normal irradiation (DNI)*	Electricity production per kW**
Parabolic trough with 7h storage	2,000 kWh/m <sup>2</sup> a	3,300 kWh/a
Parabolic trough with 7h storage (MENA)	2,500 kWh/m <sup>2</sup> a	4,050 kWh/a
Fresnel lens (Spain/south)	2,000 kWh/m <sup>2</sup> a	1,850 kWh/a
Fresnel lens (MENA)	2,500 kWh/m <sup>2</sup> a	2,270 kWh/a
Solar tower with 16h storage (Spain/south)	2,000 kWh/m <sup>2</sup> a	6,500 kWh/a
Solar tower with 16h storage (MENA)	2,500 kWh/m <sup>2</sup> a	7,000 kWh/a

Table 5.1.4: Annual electricity generation from CSP. | Source: GOPA intec, Suntrace, Fichtner.

\* Direct normal irradiation (DNI) is the amount of solar radiation received by a surface that is always perpendicular (or normal) to the incoming sun's rays (i.e. a surface directly facing the sun). \*\*Also dependent on energy storage capacity.

CPV plant	Direct normal irradiation (DNI)	Electricity production per kW
CPV (Spain/south)	2,000 kWh/m <sup>2</sup> a	1,560 kWh/a
CPV (MENA)	2,500 kWh/m <sup>2</sup> a	2,000 kWh/a

Table 5.1.5: Annual electricity generation from CPV. | Source: GOPA intec, Suntrace, Fichtner.

not produce in periods of darkness). Baseload fossil-fuel power plants and nuclear power plants can provide significantly more annual average electrical energy, sometimes up to 8,000 kWh per kW of installed capacity.

Using the LCOE method (as described above), different energy technologies can be compared with each other. This is shown in Figure 5.1.2. The average cost of electricity generated by new photovoltaic systems in Germany is between 5 and 17 euro cents per kWh. For renewable energy in MENA region, large utility-scale PV has the lowest LCOE overall, down to 3 euro cents per kWh. Electricity generation costs from fossil-fuel power plants are also given. However, it is important to bear in mind that this comparison disregards such issues as the ability of plants to generate electricity at any time/on demand [2].

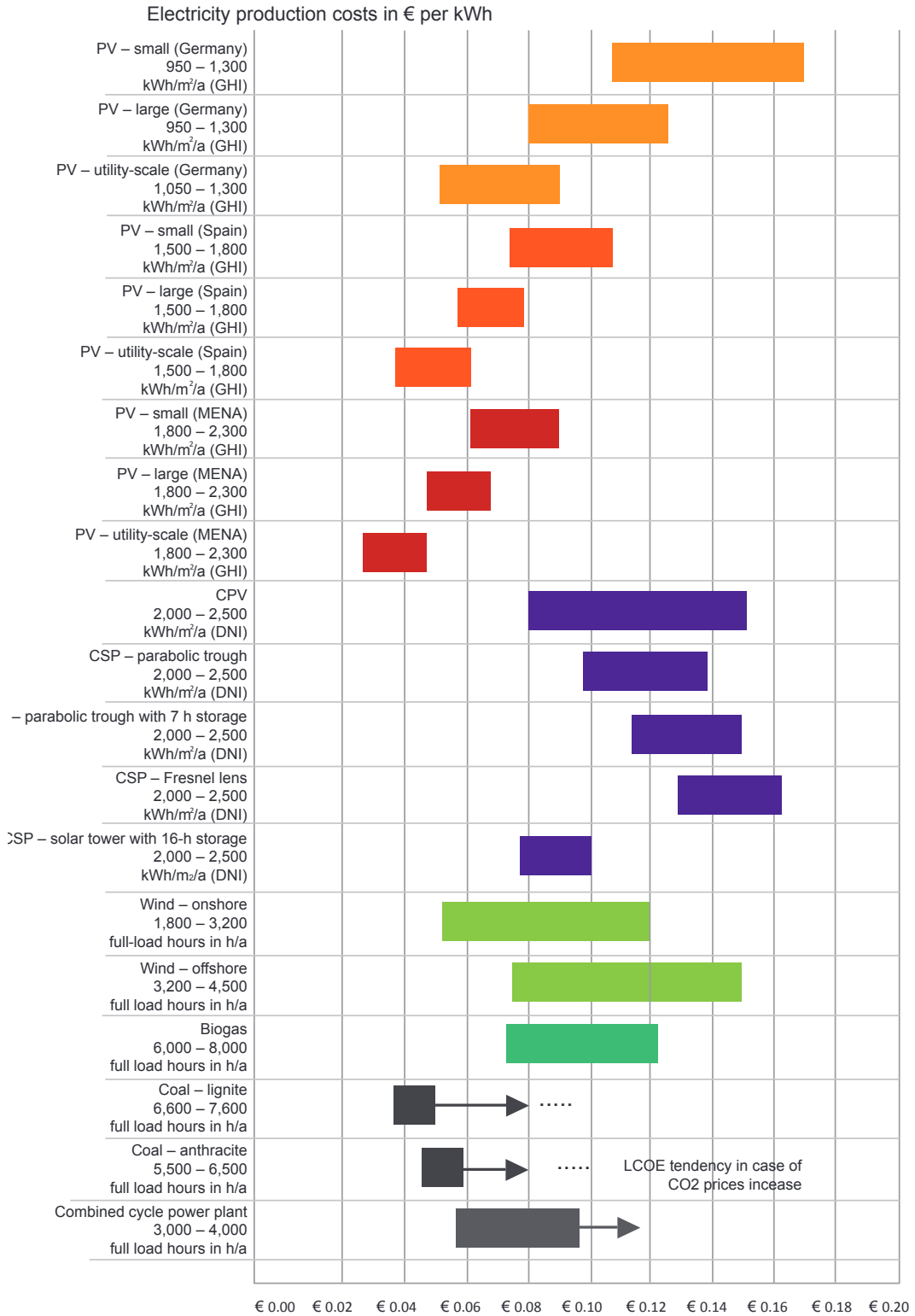


Figure 5.1.2: LCOE generated by different power generation technologies – the figures under the different technologies give the full load hours of operation (FLH) per year. For the solar systems, output is given per square metre. | Source: GOPA intec.

## 5.2 Project financing and related engineering services

*Andreas Wiese*

Renewable energy projects are predominantly privately financed. While many projects are implemented using public funds and by public bodies directly, this is limited to when renewable energy projects are being newly introduced to a market and/or to market subsectors. However, the private financing of renewable energy projects generally requires a clear regulatory framework to allow fair competition between renewable and other established, traditional supply options, with supportive elements in the initial phase of market development. The latter can be in the form of direct subsidies for privately funded projects (for example, through investment grants) or indirect subsidies (for example, through government-guaranteed feed-in tariffs), or regulatory mechanisms aimed at stipulating or encouraging that a certain proportion of the energy supply comes from renewables.

Large, privately funded projects in the renewable energy sector are often financed using the so-called ‘project financing’ approach. The term ‘project financing’ or a ‘project-financed’ refers to the loan financing of a financially and usually legally separate and self-refinancing business entity which has a limited service life. Project financing is an alternative to ‘corporate-credit-rating-based-financing’. Loans are not provided either in the traditional manner of financing – based on the creditworthiness of a business – or in the form of project-related financing based directly on the creditworthiness of the sponsors involved, but are provided on the basis of the expected economic viability of the project in itself. Project financing is therefore a type of financing in which all costs – for example, the operating costs and the capital servicing costs – are covered alone and completely from a project’s cash flow. The project risks are explicitly assigned to different project participants (risk sharing).

Figure 5.2.1 shows the key stakeholders involved a ‘project-funded’ project. The project company, which holds all project rights and which is set up during the project development phase of the project, is central. The diagram also shows the different roles which engineers can overtake within the overall project structure: in engineering, procurement and construction (EPC) activities or in operations – as a project company’s ‘owner’s engineer’, or as an ‘investor’s engineer’, or as a bank’s ‘lender’s engineer’.

Regardless of whether the project funding mechanism is project financing or another type of financing, project management for renewable energy projects can be divided



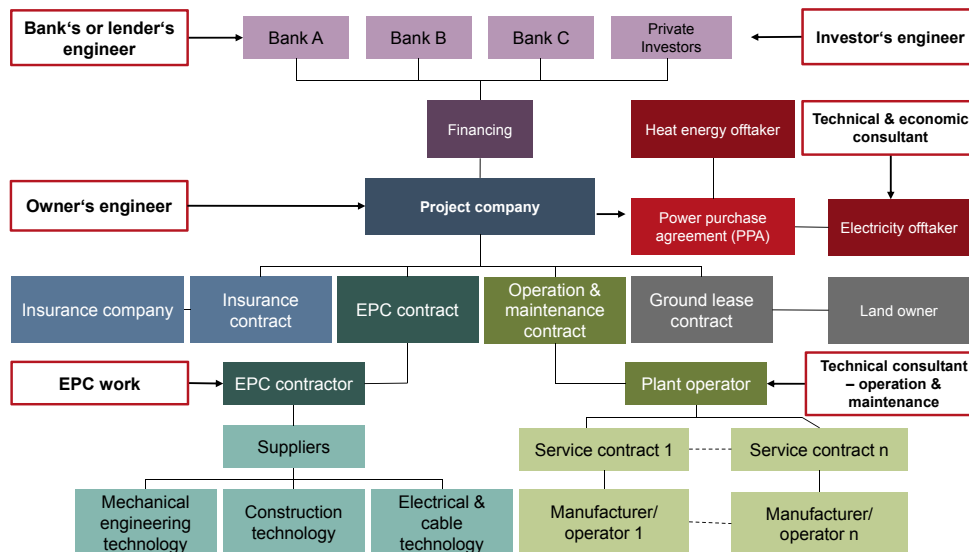


Figure 5.2.1: Organisation chart of a project-financed renewable energy project from an engineering point of view; further expertise such as essential insurance, legal and economic expertise, is not shown. | Source: A.Wiese. Graphic: RENAC.

into several project implementation phases. They can be partially realised in parallel or overlap.

The first project phase, up to the approval of project financing, can be referred to as the project development phase. This project development phase begins with the initial project idea and ends when the financing is secured (financial close). ‘Financial close’ is defined as the point in time when all the project and financing agreements between two or more parties – the owners or equity investors and the project company on one side and the lenders and banks on the other – have been signed, all the conditions contained in them have been met, all conditions for payments to the project company have been fulfilled, and all legal documents are properly registered and legally effective. The core objective of the project development phase is the development of a project though to the stage where is construction can go ahead and the project is financeable. To achieve this goal, the following tasks need to be completed:

- Planning tasks: in the case of a renewable energy project, this includes, in particular, the survey, verification and analysis of renewable energy resource availability, and an as-accurate-as-possible forecast of its availability over the entire operating life of the renewable energy plant.
- Obtaining official permits such as building permits and permits related to environmental issues: in the case of renewable energy projects, the following issues play a role in obtaining permits related to environmental issues:

- Visual impact (with wind farms especially)
  - Impact on flora and fauna (e.g. effect of wind farms on bird life)
  - Damage caused by subsoil displacement, and seismic events (very important in case of geothermal energy projects)
  - Sustainability of biomass resource utilisation
  - Waste disposal issues regarding materials with high potential negative impacts on the environment in the event of accidents/damage (e.g. cadmium-telluride PV modules)
  - Impact of large-scale plant infrastructure
  - Noise issues arising during plant operation
  - Regulations regarding distances of wind turbines from human settlements, which can vary greatly from country to country
  - Depending on the intended technology, additional special permits may be required (for example, exploration permits and mining licenses may be required for geothermal plants).
- Conclusion of the project contracts: general contractor agreement, power purchase agreements (PPAs) that secure revenue over the plant's operating life, management contracts, equity and credit agreements, land-use contracts, concessions (for example, water extraction rights for hydro projects)
  - Reliable project cost and profitability estimates
  - Securing equity and debt financing
  - Public acceptance for the project (via, among other activities, the provision of information at an early project stage, public consultations)
  - Identification of all significant project risks and the clear contractual assignment of risks to the appropriate project participants, as well as risk avoidance and risk reduction strategies.

Depending on the type of project, development times for renewable energy projects can take from a few months to several years. With some types of projects, as is often the case with wind energy projects, long resource surveys have to be carried out in the development phase; the development phase can also be lengthy where projects risks are high, such as with geothermal energy projects. Towards the end of the project development phase, and shortly before the financial close, a due diligence (DD) review needs to be carried out. A 'due diligence' review is an investigation or appraisal of a business which is undertaken prior to signing a contract in order to demonstrate that reasonable care has been taken. The due diligence review involves analysing the

strengths and weaknesses of the project and investment risks, and assesses the viability of the project. In addition to the technical due diligence, which is a key engineering task and involves, among other items, an analysis and evaluation of the technology, other due diligence reviews also need to be undertaken. These include financial due diligence and tax due diligence, market due diligence, as well as legal and possibly insurance due diligence.

The following box is a good example of a list of the tasks involved in the technical due diligence review for a photovoltaic project:

1. Evaluation of relevant climate data (irradiation, temperature, humidity): methodologies used, stations used, sensors, variances, long-term correlations, verification of the energy yield prognosis
2. Technical evaluation of the PV modules used, in particular with regard to quality, efficiency (also with regard to local climate/environmental conditions), guarantees/warranties, expected service lives
3. Technical evaluation of the intended module layout/interconnection with regard to shading, cable losses, efficiency optimisation of string circuits/layout, PV module MPP sorting, grouping in different types of PV modules
4. Technical evaluation of the planned interconnection / plant configuration strategy: central/decentral/semi-decentral inverters, inverter control / regulation unit(s), ventilation and climate compatibility of decentral inverters, evaluation of the strategy with regard to yield optimisation, service life, adaptation to given climatic conditions
5. Technical assessment of other plant components: PV module mounting systems (alignment, foundations, load calculations), cabling, cable routing, central inverter building(s) if required, grid connection, safety equipment (regarding fire, theft, personal protection)
6. Inspection of operation and maintenance plans/schedules: personnel, consumables (water availability for PV module cleaning, etc.), spare parts stock
7. Factory inspection of module production (quality, homogeneity, etc.)

8. Factory inspection of inverter production (quality, homogeneity, etc.)
9. Checking plans/schedules for delivery and installation / construction work (also with regard to possible delivery bottlenecks)
10. Technical review of contracts: supply contract for PV modules, other supply contracts, general contractor contract, maintenance contract, electricity supply contract, grid connection contract
11. Technical examination of official approval documents / permits
12. Verification of the technical data input in the financial model
13. Preparation of a due diligence report.

### **Identifying project risks in the project-financing phase**

Identifying project risks and deriving recommendations for action runs through the entire project development phase. Recommendations for action could be, for example, plan/schedule changes, additional communication strategies to improve public acceptance of the project, or even abandonment of the project due to insurmountable obstacles to implementation.

In general, a distinction can be made between endogenous and exogenous project risks. Endogenous risks are those risks which can be controlled by the project company or the project participants. Exogenous are risks that affect the project beyond the control of project participants.

### **Endogenous risks associated with renewable energy projects**

Renewable energy projects can face the following significant endogenous risks:

Resource risks, raw materials or energy resources are less or of lower quality than as foreseen in the plan; specifically, these can be:

- Wind projects: insufficient wind resources or uncertainty in knowledge about the wind resource – risk mitigation measures: site selection (avoids sites with insufficient wind resources); wind measurement campaign, one or more wind surveys (reduces uncertainty in knowledge about the wind resource)
- Solar projects: insufficient solar irradiation or uncertainty in knowledge about the solar resource – risk mitigation measures: site selection (avoids sites with insufficient solar resources); solar measurement campaign, one or more solar resource surveys (reduces uncertainty in knowledge about the solar resources)
- Biomass: low biomass supply – risk mitigation measures: biomass availability study, higher biomass input costs.

Technical risks associated with the technology used:

- Risk mitigation measures
  - Use of technology appropriate to the site and which is proven (state-of-the-art technology)
  - Sufficient number of other identically constructed or similar installations to demonstrate that the technology performs to expected standards
  - Sufficiently high technical quality for work and equipment in tenders put out
  - Defining/specifying and including the above in an appropriate general contractor agreement or supplier contracts
  - Defining/specifying appropriate standards
  - Requiring internationally recognised certification
  - Use of appropriately qualified engineering firms by the owner (owner's engineer), by the general contractor (contractor's engineering capabilities) and with the banks (lender's engineer).

Technical risks associated with project completion:

- Project completion but not according to contract, such as:
  - Late completion
  - Completion at higher cost, for example because of technical changes
  - Non-completion: the expected revenues do not justify project completion or project completion is technically impossible.

Risk associated with project completion has a direct impact on cash flow because of reduced or delayed revenues and increased expenses. This risk is usually shifted/

transferred to the general contractor or supplier, or, in rare cases, to the project sponsors or equity investors.

- Risk mitigation measures
  - Selection of suitable equipment suppliers
  - Fixed prices
  - Completion guarantees (plant supplier, EPC contractor, project sponsors)
  - Additional funding obligations for sponsors.
- An evaluation of the risks associated with the financial position/strength of companies involved in the project should be undertaken: this applies to general contractors, suppliers and plant operators, but also to the company which takes delivery of the final product (e.g. electrical energy) and is therefore responsible for providing all project revenues over the entire project duration: is this company in a financial position to take on this contractual obligation? What liability can it take on? Could other companies step in?

### **Significant exogenous risks associated with renewable energy projects**

Renewable energy projects can face the following significant exogenous risks:

- Interest rate risks: particularly significant in capital-intensive projects, which most renewable energy projects are; risk can be mitigated/avoided via interest rate hedges in the form of so-called swaps, caps or other derivative financial instruments
- Inflation and currency risks: cost increases due to price increases; and, with PPAs without suitable indexation clauses, reduction of revenue from electricity sales.
- Country-specific risks:
  - Political risks such as changes of government, delays in licensing procedures, policy changes, revocation of concessions, expropriation, nationalisation – can be mitigated/avoided by state export credit guarantees (Hermes cover)
  - Sovereign risk: inability or unwillingness of a country to meet its credit obligations or to allow companies to settle their obligations to creditors, lack of currency conversion options, temporary or permanent bans on payments.

## Risk management

Dealing with all these risks during the project development phase takes place via risk management, taking into account the principle of risk sharing. The tasks associated with this can be understood as a cyclical process, which include in particular:

- Definition of acceptable risk exposure
- Identification of project risks
- Quantification and description of the project risks / risk profile
- Risk mitigation planning (supported by the risk manager)  
Risk mitigation implementation (supervised by the risk manager)
- Revaluation.

One of the main risk management tasks is quantifying and controlling the project risks. The aim is to develop a decision-making basis for the selection of risk-policy measures which can reduce project risks to an acceptable level.

Risk management thus involves the mitigation of 'negative risks' and the promotion of 'positive' risks (opportunities). In smaller projects, this task is shared by the project leader and all team members. In large projects, such as offshore wind farms, risk management is a distinct activity carried out by distinct personnel (risk managers) and accounted for separately. Risk management conclusions and recommendations need to be continuously taken into account in ongoing costing and profitability calculations.

### 5.3 Funding possibilities for renewable energy projects

*Thomas Kraneis*

Along with formulating technical proposals for renewable energy projects, the question quickly arises of what state/government financing options are available in addition to traditional project financing options (see Chapter 5.2). Financing possibilities for renewable energy projects are currently available in almost every country. In the realm of public funding options, there are state subsidies; but because renewable energy projects can generate considerable returns on investment, the private sector has also become very interested in financing projects. In addition to national institutions, there are also globally active financing agencies (see Table 5.3.1).

The financial institutions listed in Table 5.3.1 all have special programmes for renewable energy projects. Because the investment costs for renewable energy have fallen dramatically over the last 15 years, excellent payback periods can be achieved using loan finance, which means that renewable energy projects can show a profit after only a few years of operation. This development is particularly noticeable in the photovoltaic and wind power sectors. In the photovoltaics sector, investment costs have fallen by 90% of what they were 15 years ago. In the wind energy sector also, the investment costs per megawatt of power have fallen dramatically, mainly due to the increased size of wind turbines. The state of the art currently on the global market are turbine sizes of 10 MW; machines of this size are mostly used in the offshore sector.

The profitability of renewable energy plants is also reflected in power purchase agreements (PPAs). For example, in the Arab world, PPAs were concluded in 2018 to deliver electricity at a price of 3 US cents per kWh. PPA prices for wind energy in the US and China are already below 5 US cents per kWh – and this price will soon be reached even for European offshore wind projects.

Each financing application requires a ‘bankable feasibility study’ or a well-formulated project proposal. All financing institutions will have specific requirements that need to be met. If an application for finance is refused, the reasons should be investigated and dealt with prior to making an improved financing application [3] [4].



Institution	Website
World Bank	worldbank.org
International Finance Corporation, IFC	ifc.org
UN Organisations	un.org
Caribbean Development Bank	caribank.org
African Development Bank, AfDB	afdb.org
Asian Development Bank, ADB	adb.org
OPEC Fund	ofid.org
Saudi Fund	sfd.gov.sa
Abu-Dhabi Fund	adfd.ae
Kuwait Fund	kuwait-fund.org
European Investment Bank, EIB	eib.org
European Bank for Reconstruction and Development	de.ebrd.com
Kreditanstalt für Wiederaufbau, KfW	kfw.de
Deutsche Investitions- und Entwicklungsgesellschaft, DEG	deginvest.de
Standard Bank	standardbank.co.za
Deutsche Bank	deutsche-bank.de
Commerzbank	commerzbank.de

Table 5.3.1: Globally active financing agencies for renewable energy projects.

## 5.4 Independent power producer arrangements

*Fabian Kuhn*

There are several approaches to promoting the installation and use of photovoltaic (PV) systems. An initial approach was the use of feed-in tariffs (FITs). One of the first countries to introduce FITs was Germany in 2000, via the Renewable Energy Sources Act (EEG). The EEG provided the regulatory framework that enabled the total electricity generated by renewable grid-connected systems and plants, including PV, to be fed into the electric grid. The electricity is remunerated at a fixed rate per kWh, depending on the size of the PV system and the date at which the system was installed/commissioned. However, for some years now, other approaches have also been pursued, especially for large-scale renewable energy projects. These are not based on feed-in tariffs but on the actual electricity production costs and on solar irradiation levels.

They are:

- Independent power producer (IPP) auctions
- Unsolicited bids to state energy suppliers
- Private projects.

### Independent power producer (IPP) auctions

In independent power producer (IPP) auctions (also known as renewable energy auctions) for PV projects, IPP project developers make bids, and the utility selects an IPP project developer to 'build, own and operate' (BOO) a PV power plant which then sells the electricity generated to the utility. The terms, the tariffs and all other guarantees and conditions are specified in a power purchase agreement (PPA). The usual duration of a PPA is between 15 and 25 years.

In some cases, IPP project developers are also responsible for locating potential sites, connecting to the grid, carrying out site surveys and obtaining official approvals and permits (for example, in South Africa, Chile, and India, as well as in Germany). In some countries, sometimes, sites are pre-developed by the utility, with soil surveys, topographical studies and environmental impact assessments already carried out (for example, in the UAE, Egypt, Saudi Arabia, or Jordan).

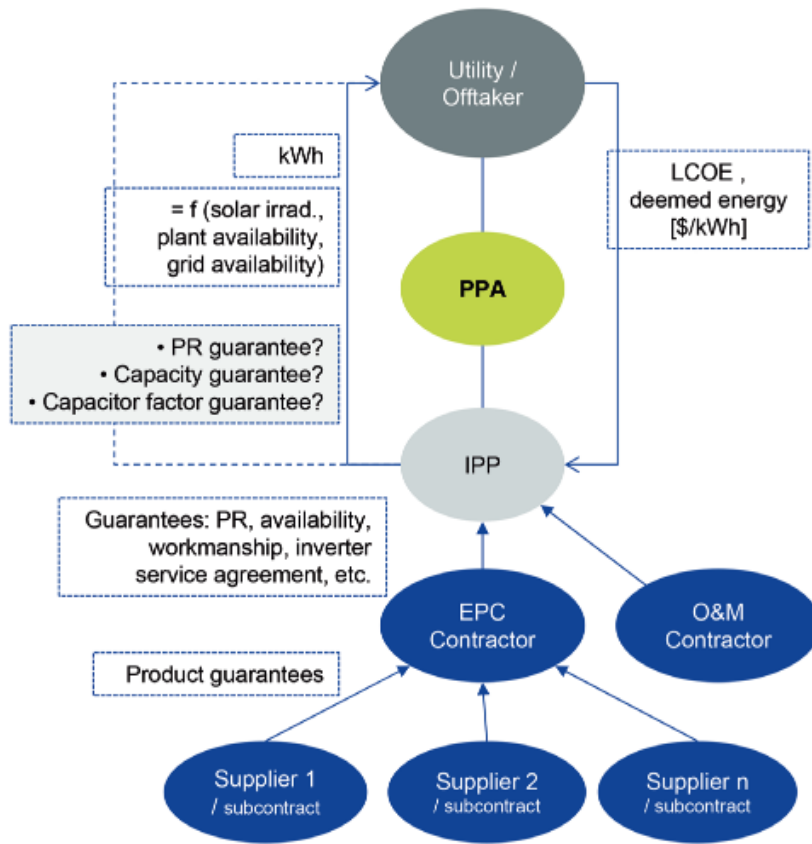


Figure 5.4.1: Typical structure of an IPP arrangement. | Source: Fichtner

### Unsolicited bids to state utilities

With unsolicited bids to state utilities, the IPP project developer prepares the project in advance, submits an offer and, if the offer is accepted, signs a power purchase (PPA) with the state utility.

### Private projects

Private projects are projects in which companies in energy-intensive industries, such as mining companies or farms, located in isolated or remote areas, invite interested IPP project developers to bid for the installation and operation of a PV power plant to supply them with electricity. The IPP and the company then sign a power purchase agreement (PPA) which sets out the terms and conditions governing the sale of the electricity. If required, the PV plant can also include electricity storage in order to regulate frequency in the local (private) grid and cover loads when levels of solar radiation are fluctuating and, in addition, part of the solar electricity generated can be stored for use in the evening hours when the sun is no longer shining, but electricity is still required.

## 5.5 Self-consumption and direct marketing of solar power in Germany

*Thomas Schubert*

The expansion of renewable energy has led to a decentralisation of electricity generation in Germany and elsewhere. Increasingly, large quantities of electricity are being generated from renewable energy sources via a large number of smaller power plants rather than being generated in centralised large-scale power plants. This has led to various challenges because, among other things, the electricity generated by these smaller renewable energy plants is being fed directly onto the lower-voltage distribution grid.

For most private small and micro-systems, the green electricity fed into the grid is usually remunerated at a fixed rate (feed-in tariff or FIT) stipulated in the German Renewable Energy Sources Act (German: *Erneuerbare-Energien-Gesetz*, EEG). The 'metered' 'self-consumption' of the electricity generated by households and small businesses – usually by photovoltaic (PV) systems – or the direct sale of electricity to nearby consumers is currently the exception. (In general the power generated is consumed by the nearest loads, but the definition of 'self-consumption' refers to the point at which the generated electricity is metered). Due to the steadily decreasing feed-in tariffs, feeding all the electricity generated by these small systems into the grid is increasingly less economically attractive. At the same time, the falling prices for renewable energy electricity-generating systems, and the resulting lower levelised cost of electricity (LCOE) that this implies, means that generation for 'self-consumption' – or to sell directly to customers in close proximity – makes sense from an economic point of view.

Whether self-consumption or directly supplying end-users (final consumers) with electricity generated from renewable sources is actually economically worthwhile also depends on which taxes, other fees and charges (in particular grid charges) have to be paid by the end-user. In general, and with regard to Germany, the price of electricity to be paid by end-consumers consists of the following components:

- Cost of electricity generation / distribution / supplier's margin
- EEG levy (German: *EEG-Umlage*, levy on electricity to end-users to fund EEG FITs, also called EEG surcharge)
- Grid fees/charges
- Taxes and other charges.

In Germany, self-consumption and the supply of electricity to nearby end-users is associated with an exemption from taxes and charges generally incurred by electricity end-consumers. However, legislators have set very stringent conditions for these exemptions. Special remuneration schemes have also been initiated in order to facilitate the supply of electricity generated by PV systems to tenants in residential buildings.

## Self-consumption

Electricity generation for one's own use has a long tradition in Germany, especially by larger industrial plants. But it is only recently that it has been possible to meet one's own electricity needs using renewable energy systems.

'Self-consumption' is defined in the EEG by the following criteria:

- Both the production and consumption of the electricity occurs in the same building or on the same premises;
- There is no distribution through an external network/grid; and
- The system/plant operator(s)/owner(s) and the electricity consumer(s) are the same entity.

The most important of these is that the system operator/owner and electricity consumer are identical. The system or plant operator is defined as the natural or legal person who carries the economic risk for the plant; it does not depend exclusively on actual ownership.

There are specific regulations in the EEG regarding self-consumption and the EEG levy – which in principle should also be paid in full by self-consumers/self-suppliers for the self-generated electricity they consume – that reduce or completely eliminate the EEG levy for self-consumption system operators.

According to the current legislation, four forms of self-consumption are completely exempt from the EEG levy, but only one of these explicitly deals with electricity generation from renewable energies:

- Power plant self-consumption: the electricity is consumed to operate the plant or its ancillary and auxiliary facilities for power generation
- Off-grid or stand-alone systems/plants: the system/plant is not connected to a public electric grid

- Complete self-supply with electricity generated from renewable energy if no EEG remuneration is claimed for any feed-in into the grid, or
- Generation of electricity by systems/plants with a maximum installed capacity of 10 kW for up to 10 MWh of self-consumed electricity per year.

With regard to electricity generation from renewables, self-consumption is of interest mainly to homeowners with small PV systems and large consumers who can generate all the renewable electricity they require for their own needs.

The EEG also stipulates that if the electricity generated by a self-consumer/self-supplier is produced from renewable energy, or from mine gas, or from a highly efficient CHP plant, but in a situation not in one of the categories mentioned above, the EEG levy is reduced to 40% of what it normally would be. Special regulations apply to systems/plants with energy storage.

In addition to the exemption from the EEG levy, self-consumption arrangements can profit from additional benefits, in particular from an exemption from electricity tax (German: *Stromsteuer*), exemption from grid fees/charges and other surcharges linked to grid fees/charges, and from the offshore liability levy (German: *Offshore-Haftungsumlage*, levy on electricity end-users to support offshore wind farms).

### Regional and local direct marketing

With the 2014 EEG, ‘direct marketing’ (German: *Direktvermarktung*) became the standard remuneration model and feed-in-tariffs became the exception – mainly for already existing systems and small systems. Renewable energy installations with an installed capacity of 100 kW or above, and which were commissioned as of 1 January 2016, must directly market the electricity they generate. A system operator or a third party (an electricity trader, for example) who markets the electricity directly is entitled to receive a market premium from the network/grid operator. This market premium is a subsidy added to the price that can be achieved through direct marketing of the electricity, and it is designed to cover the higher electricity generation costs of renewables as compared to those of conventional power generation. The aim of this direct marketing model is to gradually shift renewables from being financed through a statutory compensation entitlement towards being financed through a market-based environment.

A special form of direct marketing is so-called ‘regional direct marketing’ (German: *regionale Direktvermarktung*). In this case, the electricity fed into the grid is not traded

on the electricity exchange/market, but sold to local industrial consumers or domestic customers. In contrast to self-consumption, the producer/plant operator and consumer do not have to be the same. However, spatial proximity is required.

Regional direct marketing is promoted solely by an exemption from electricity tax. Electricity sales are exempt from this tax if, amongst other things, the electricity:

- is generated by a system with a rated electrical output of up to 2 MW, and
- is provided by the plant operator to final consumers, who –
- are in spatial proximity to the system (defined as within a radius of up to 4.5 km of the power generation unit).

However, the electricity tax exemption for regional direct marketing does not apply to electricity generation from renewables that is already being subsidised under the EEG. In this case, the grid operator has to reduce the EEG feed-in tariff or market premium by the amount of the electricity tax. In the case of 'local direct marketing' (German: *lokale Direktvermarktung*) the public electric grid is not used at all. In this case, in addition to the exemption from electricity tax, operators are also exempt from grid fees/charges and other surcharges linked to grid fees/charges, and the offshore liability levy. When supplying electricity to consumers using the public grid, the full EEG levy and other levies payable by the electricity offtaker become payable

### Tenant electricity model

Another form of direct supply of renewable electricity is via the so-called tenant electricity model or scheme (German: *Mieterstrommodell*). In mid-2017, the Tenant Electricity Law (German: *Mieterstromgesetz*, incorporated in the EEG) came into force, which particularly promotes the supply of locally produced electricity from PV systems to the tenants of rented accommodation.

The PV system operator receives a premium on electricity (German: *Mieterstromzuschlag*) sold to tenants for a period of 20 years, which is based on the installed capacity of the PV system. With an installed capacity of 10 kW this is 3.7 euro cents per kWh, 3.37 euro cents per kWh up to 40 kW, and 2.11 euro cents per kWh up to 100 kW. These values are reduced according to when the system was installed, as regulated in the EEG.

A prerequisite for eligibility for this scheme is, in principle, that one or more newly installed PV systems with a total installed capacity of not more than 100 kW is installed on the residential building or adjoining it. For a building to qualify as a residential building, 40% residential use is required. In addition, the supply and consumption of the electricity generated by the PV system must be provided to the tenants as end-consumers within the residential building or in its immediate proximity, without being transmitted through the public electric grid. There is an annual cap of 500 MW of new installations per year which can be eligible for this scheme. As regards the electricity supply contracts to be concluded with tenants, it should be noted that there is no compulsory purchase obligation for tenants. Tenants are free to freely choose their own electricity provider. This may not be circumvented by linking the electricity supply with rental agreements. The maximum contract period for electricity supply contracts is one year, with automatic renewal for another one year. Furthermore, there is an upper price limit of 90% of the basic service tariff in the respective grid area.

#### References

- /1/ [https://en.wikipedia.org/wiki/Advanced\\_CANDU\\_reactor](https://en.wikipedia.org/wiki/Advanced_CANDU_reactor)
- /2/ Wiese, A.: Vorlesung Wirtschaftlichkeit einer regenerativen Energiebereitstellung, Technische Universität Hamburg-Harburg, Institut für Umwelttechnik und Energiewirtschaft.
- /3/ IRENA, 2018: Renewable Power Generation Costs in 2017.
- /4/ [https://en.wikipedia.org/wiki/Cost\\_of\\_electricity\\_by\\_source](https://en.wikipedia.org/wiki/Cost_of_electricity_by_source)



## 6 Consulting Engineering Services – Remuneration

*Fabian Kuhn*

The remuneration of independent engineering consulting and design/planning services in the international renewable energy sector depends on the client / project sponsor and the end-beneficiary of the services, but also on the nature of the project. (In some cases, for example in international projects, the client may be an international donor or sponsor, and not the end-beneficiary of the project.). Figure 6.1 illustrates the range of possible clients/customers and the possible services that can be provided by engineering consultants. The largest potential customer bases are usually banks (lenders), investors, project developers and energy utilities.

Typical services offered by consulting engineers include:

- Carrying out feasibility studies
- Preparation of tender documents/specifications
- Technical due diligences for project financing
- Construction supervision and witnessing of the acceptance tests
- Monitoring of plant operation.

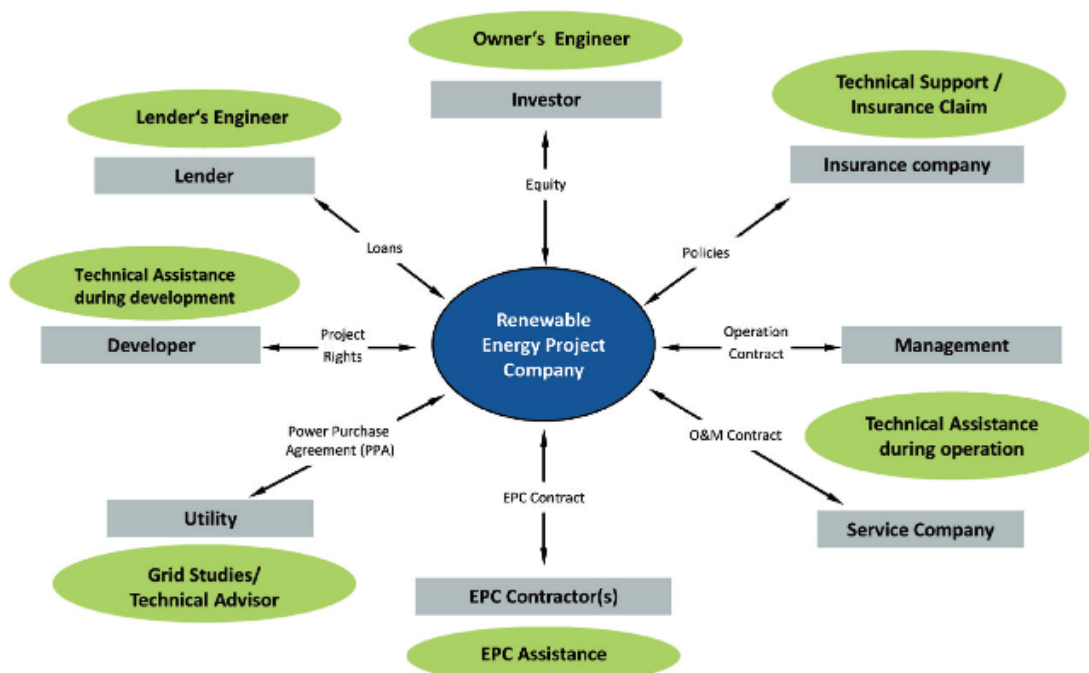


Figure 6.1: Clients and consulting engineering services in the renewable energy sector. | Source: Fichtner.

Figure 6.2 shows the types of services provided by an ‘owner’s engineer’ or a ‘lender’s engineer’.

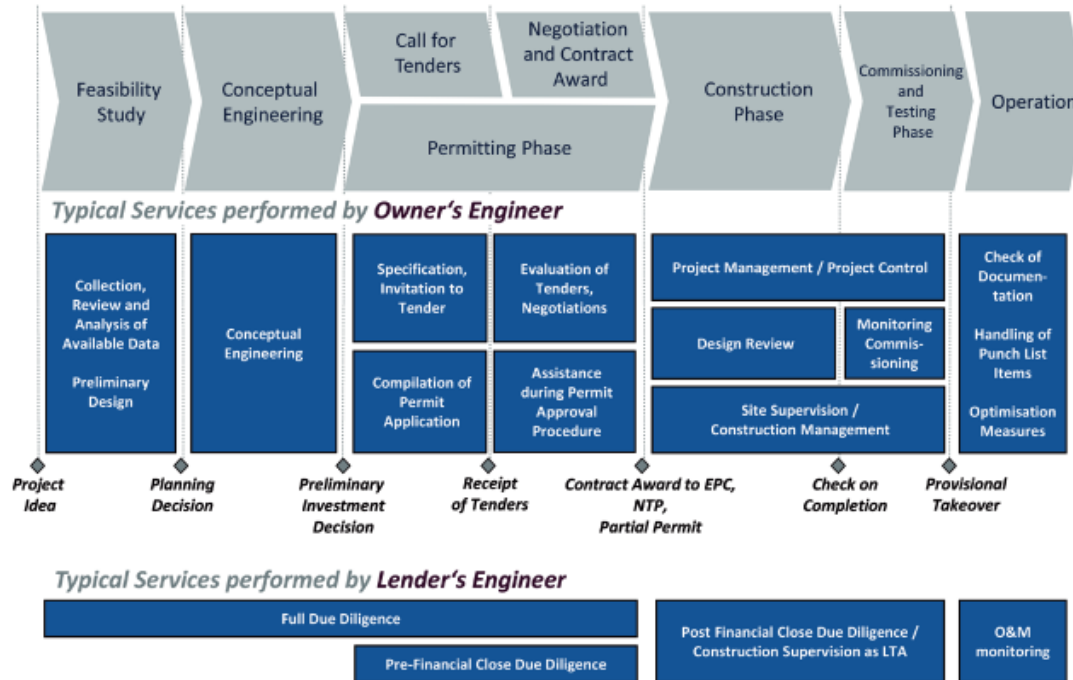


Figure 6.2: Types of consultancy services offered by owner's engineer and lender's engineer. (LTA means 'lender's technical advisor'.) | Source: Fichtner.

Types of remuneration/fees for services provided usually fall into one of the following categories:

1. Fixed price plus ancillary costs
2. Fixed price without ancillary costs
3. Billing of work done with cap (upper limit)
4. Billing of work done without cap (upper limit).

Each of these four categories has associated advantages and disadvantages.

### 1) Fixed price plus ancillary costs

With a 'fixed price plus ancillary costs' contract, both the risks and the opportunities lie with the consultant (or consultancy firm). The scope of work of work should include a clear description of the services to be provided, as well as a list of assumptions and limitations such as the number of iterations and/or the duration of a site appraisal. The

consultant bears the risks if the budget is not sufficient, exposing the consultant to unanticipated overheads associated with the services offered in the work package.

On the other hand, when a consultant contracts for a fixed price for a work package, the consultant has an incentive to process the work efficiently. If the work is completed faster than planned, and to the satisfaction of the customer, the consultant will make a profit through unused but billed 'days' (daily rates), which means that it is in the interest of the consultant to complete the project quickly. If the customer requests additional services, these are usually billed as a supplementary item. If expenses such as flights or accommodation costs are included in the fixed price, it is up to the consultant to keep them below or within the amount originally calculated.

The fixed price consists of the charge for 'billable days' and any other additional costs. It may also include a risk premium to cover unforeseen eventualities. If there are competitors for the job or if a consultant has the goal of gaining a foothold in new markets or countries, the consultant may price the job more aggressively/at a lower price in order to maximise the likelihood of winning the contact. Under certain circumstances, this can however mean that consultants may not cover their costs.

Work is usually invoiced when pre-defined milestones are reached, for example:

- Advance payments (20%)
- Site inspection (15%)
- Submission of provisional report (25%)
- Submission of final report (40%).

## **2) Fixed price without ancillary costs**

'Fixed price without ancillary costs' contracts differ from 'fixed price plus ancillary costs' in that any additional costs incurred during the work are charged separately. The client does not have to pay any unnecessary extra charges if the consultant firm has calculated the ancillary costs covered by the fixed price in the offer too conservatively (for example, because the consultant firm did not know how high these ancillary costs might actually be).

### 3) Billing of work done with cap (upper limit)

With 'billing of work done with cap' contracts, the consultant logs the time spent on the job via time sheets. These proofs of work are sent with invoices to the client, for example every month. For the client, this procedure has the advantage of being highly transparent, giving an on-going overview of project status and the corresponding costs. In the bid for the job, the consultant describes what services will be provided and an estimate of the corresponding cost/fees. When concluding the contract, a maximum payment (a cap) for the services to be provided is agreed on, and this normally cannot be exceeded. This form of billing is not always an attractive option for consultants because a potential profit margin has to be calculated for in the negotiated daily rate. However, the risk for the consultant is also limited: if justified additional work is required on reaching the 'cap', a supplementary budget can be agreed (i.e. an increase in the cap).

### 4) Billing of work done without cap (upper limit)

Billing of work done without cap' contracts are similar to 'billing of work done plus cap' contracts, but extra charges for additional work do not have to be negotiated during the work. The financial risk for the client tends to be higher because there is no upper limit on what can be charged by the consultant. For the consultant, the attraction of a contract of this type of contract without a cap on what can be billed is more that it keeps their staff employed rather than simply profit maximisation. As with 'billing of work done plus cap' contracts, the consultant has to calculate a profit margin into the negotiated daily rate. On the other hand, if the consultant has successfully negotiated the daily rate, it can in the long run also lead to good profits for the consultant.

### 5) Contract templates

A suitable contract template for independent engineering consulting and design/planning services is found in the FIDIC White Book, which has also been published in German by VBI. (FIDIC is the International Federation of Consulting Engineers.) The FIDIC White Book sets standards for the contracts between consultants and the clients in international projects, and is also used by international banks such as the KfW Development Bank as a template and contract formulation aid.

Engineering consulting services tend to be evaluated mainly on the basis of technical competencies, such as the CVs of the experts, examples of projects of similar type and scope which have been completed by companies, and relevant experience in the project country. The financial side of bids for contracts (the *price* of the engineering services offered) plays a lesser role. International donors usually evaluate bids at 80% technically

and 20% financially; other weightings are possible, but the weighting given to the technical side of bids is nearly always over 60%.

#### References

/1/ <https://www.whitecase.com/publications/alert/new-fidic-white-book-consultancy-services> und [https://www.vbi.de/fileadmin/redaktion/Dokumente/Infopool/Dispute\\_Adjudication/FIDIC\\_White\\_Book\\_2017\\_und\\_andere\\_Regelwerke.pdf](https://www.vbi.de/fileadmin/redaktion/Dokumente/Infopool/Dispute_Adjudication/FIDIC_White_Book_2017_und_andere_Regelwerke.pdf).

## 7 Abbreviations

AC	Alternating current
AEL	Alkaline electrolysis
BHE	Borehole heat exchanger
BNetzA	<i>Bundesnetzagentur</i> , German Federal Network Agency
BMS	Battery management system
BMWi	<i>Bundesministerium für Wirtschaft und Energie</i> , German Federal Ministry for Economic Affairs and Energy
CAES	Compressed air energy storage
CAPEX	Capital expenditures
CDM	Clean Development Mechanism
CHP	Combined heat and power
COP	Conference of the Parties
CPV	Concentrated photovoltaics
CSP	Concentrating (or concentrated) solar power
DC	Direct current
dena	<i>Deutsche Energie-Agentur</i> , German Energy Agency
DNI	Direct normal irradiance
DSM	Demand side management
EEG	<i>Erneuerbare-Energien-Gesetz</i> , German Renewable Energy Sources Act
EPC	Engineering, procurement, construction
EU	European Union
FIT	Feed-in tariff
GHI	Global horizontal irradiance
GIS	Geographic information system
GW	Gigawatt
GWh	Gigawatt-hour
HVDC	High-voltage direct current
INDC	Intended nationally determined contributions
IPP	Independent power producer
JI	Joint Implementation
kW	Kilowatt
kWh	Kilowatt-hour
LCOE	Levelised cost of electricity
MENA	Middle East and North Africa region
MW	Megawatt
MWh	Megawatt-hour

O&M	Operation and maintenance
OPEX	Operating expenses
PEMEL	Proton-exchange membrane electrolysis
PHES	Pumped hydroelectric energy storage
PSH	Pumped-storage hydroelectricity
PPA	Power purchase agreement
PPP	Public-private partnership
PV	Photovoltaics
RE	Renewable energy
SNG	Substitute or synthetic natural gas
TWh	Terawatt-hour
UGS	Underground gas storage
VBI	<i>Verband Beratender Ingenieure</i> , German Association of Consulting Engineers

Verband Beratender Ingenieure  
(German Association of Consulting Engineers)

Budapester Straße 31  
10787 Berlin  
Germany

Phone: 030 26062 0  
Fax: 030 26062 100  
Mail: [vbi@vbi.de](mailto:vbi@vbi.de)  
[www.vbi.de](http://www.vbi.de)